

Operation Manual of the Intelligent Controller SR288

for Split Pressurized Solar Hot Water System



Please read the instruction carefully before operation!

Contents

1. Safety information	3
1.1 Installation and commissioning	3
1.2 About this manual	3
1.3 Liability waiver	3
1.4 Important information.....	4
1.5 Signal description	4
1.6 Button and HMI description	4
2. Overview	5
2.1 Technical data	5
2.2 Delivery list.....	6
3. Installation	6
3.1 Mounting controller	6
3.2 Wiring connection.....	7
3.3 Terminal connection.....	7
3.4 R3 ports for 3-ways valve / pump connection.....	9
3.5 Connection with high efficiency pump	9
4. System description (Standard solar system with 1 tank, 1 collector field)	10
5. Function's parameters and options	12
5.1 Overview of menu structure	12
5.2 Menu operation description	12
5.3 Value checking	13
5.4 Function checking	13
6. Functions operation and parameters setting (for user)	14
6.1 CLK Time setup.....	14
6.2 THET Timing heating	14
6.3 CIRC DHW circulation pump controlled by temperature or by time	17
7. Function operation and parameter setup (for engineer)	22
7.1 PWD Password	22
7.2 LOAD tank heating	22
7.3 COL Collector function.....	25
7.4 PUMP Pump control mode	30
7.5 COOL Cooling function.....	33

7.6 AUX Auxiliary function	37
7.7 MAN Manual operation	41
7.8 BLPR Blocking protection	42
7.9 OTDI Thermal Disinfection function	42
7.10 OPAR Parallel relay	44
7.11 OHQM Thermal quantity measurement	45
7.12 FS Flow meter selection and flow rate monitoring	48
7.13 UNIT C-F Switch.....	50
7.14 RET Reset.....	50
7.15 PASS Password setup.....	51
7.16 M.H Manual heating	52
7.17 Holiday function	52
8. Protection function.....	53
8.1 Memory function during power failure	53
8.2 Screen protection	53
8.3 Trouble checking	53
9. Quality Guarantee	54
10. Accessories	55

1. Safety information

1.1 Installation and commissioning

- When laying wires, please ensure that no damage occurs to any of the constructional fire safety measures presented in the building.
- The controller must not be installed in rooms where easily inflammable gas mixtures are present or may occur.
- The permissible environmental conditions can't be exceeded at the site of installation.
- Before connecting the device, make sure that the energy supply matches the specifications that the controller requires.
- All devices connected to the controller must be conformed to the technical specifications of the controller.
- All operations on an open controller are only to be conducted cleared from the power supply. All safety regulations for working on the power supply are valid.
- Connecting and /or all operations that require opening the collector (e.g. changing the fuse) are only conducted by specialists.

1.2 About this manual

This manual describes the mounting, functions and operation of a solar controller used for a solar hot water system, for mounting of other devices of a completed solar hot water system like solar collector, pump station and storage, please is sure to observe the appropriate installation instructions provided by each manufacturer. Mounting, wire connecting, commissioning and maintenance of this controller may only be performed by the trained professional person; the professional person should be familiar with this manual and follow the instructions contained herein.

1.3 Liability waiver

The manufacturer can't monitor the compliance with these instructions or the circumstances and methods used for installation, operation, utilization and maintenance of this controller. Improper installation can cause damages to material and person. This is the reason why we do not take over the responsibility and liability for losses, damages or cost that might arise due to improper installation, operation or wrong utilization and maintenance or that occurs in some connection with the aforementioned. Moreover we do not take over liability for patent infringements or infringements – occurring in connection with the use of this controller on the third parties rights. The manufacturer preserves the right to put changes to product, technical data or installation and operation instructions without prior notice. As soon as it becomes

evident that safe operation is no longer possible (e.g. visible damage). Please immediately take the device out of operation. Note: ensure that the device can't be accidentally placed into operation.

1.4 Important information

We have carefully checked the text and pictures of this manual and provided the best of our knowledge and ideas, however inevitable errors may exist. Please note that we cannot guarantee that this manual is given in the integrity of image and text, incorrect, incomplete and erroneous information and the resulting damage we do not take responsibility.

1.5 Signal description



Safety indication: Safety indications in the text are marked with a warning triangle.

They indicate measures which can lead to injury of person or safety risks.



Operation steps: small triangle "▶" is used to indicate operation step.















Note: Contains important information about operation or functions.

1.6 Button and HMI description



➤ Controller is operated with the 6 buttons on the right side of the screen

- "  " holiday button
- "M.H" button: manual heating
- "SET" button: confirm / selection
- "▲" up button: increase the value
- "▼" down button: reduce the value
- "ESC" button return/ exit : return to previous menu

Status description	Code	Lighting	Blinking
Exceed the maximum temperature of storage	SMX		
Running of storage emergency shutdown function			
Running of collector emergency shutdown function	CEM		 + 
Collector Cooling	OCCO		
Tank Cooling	OSTC		
System Cooling	OSYC		
Start of anti-freezing function	OCFR		
Running of anti-freezing function	OCFR		
Collector minimum temperature	OCMI		 Slow blink

2. Overview

2.1 Technical data

- **Inputs:**
 - 1 * PT1000 temperature sensor input
 - 5 * NTC10K, B=3950 temperature sensor input
 - 1 * Grundfos Direct Sensor TM (VFS) simulation input
 - 1 * FRT rotary vane type electronic flow meter
 - 1 * 485 communication port
- **Outputs:**
 - 2 * Electromagnetic relay, maximum current 2A
 - 2 * Semiconductor relay, maximum current 2A
 - 1 * Potential-free extra-low voltage relay (on/off signal), possible combined with HR controller
 - 2 * PWM variable frequency output (on/off switchable, 0-10V)
- **Functions:** operating hours counter, tube collector function, thermostat function, pump speed control, heat quantity measurement, external heat exchange, adjustable system parameters and optional functions (menu-driven), balance and diagnostics
- **Power supply:** 100...240V ~(50...60Hz)
- **Rated impulse voltage:** 2.5KV
- **485 current supply:** 60mA
- **Housing:** Plastic ABS
- **Mounting:** Wall mounting

- **Operation:** 6 push buttons at the front cover
- **Protection type:** IP41
- **Ambient temperature:** 0 ... 40 °C
- **Dimensions:** 187*128*46mm



Note: there are 5 inputs for NTC10K, B=3950 temperature sensor, but only 4 sensors are included in standard delivery list, the other one should be purchased separately by customer if necessary.

2.2 Delivery list

- 1 * SR288 controller
- 1 * Accessory bag
- 1 * User manual
- 1 * PT1000 temperature sensor (φ6*50mm,cable length 1.5meter)
- 4 * NTC10K temperature sensor (φ6*50mm,cable length 3meter)

3. Installation



Note: The unit must only be located in the dry interior rooms. Please separate routing of sensor wires and mains wires. Make sure the controller as well as the system is not exposed to strong electromagnetic fields.

3.1 Mounting controller

Follow the below steps to mount the controller on the wall.

- Unscrew the crosshead screw from the cover and remove it along with the cover from the housing.
- Mark the upper fastening point ① on the wall. Drill and fasten the enclosed wall plug and screw leaving the head protruding.
- Hang the housing from the upper fastening point and mark the lower fastening points ②.
- Drill and insert lower wall plugs.
- Fasten the housing to the wall with the lower fastening screw and tighten.
- Carry out the electrical wiring in accordance with the terminal allocation
- Put the cover on the housing. Attach with the fastening screw.

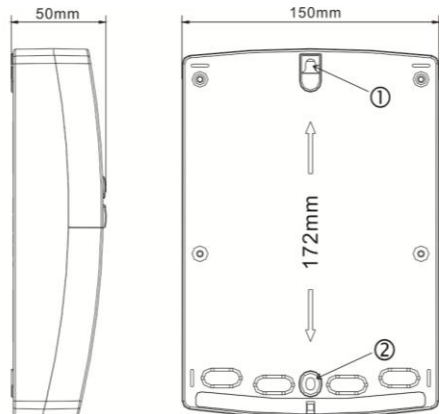

3.2 Wiring connection

According to the way of installation, wire can be connected from hole A on the bottom plate or from hole B, using a suitable tool (like knife) to cut the plastic of A.

Note: wires must be fastened by fixing clamps on the position C.

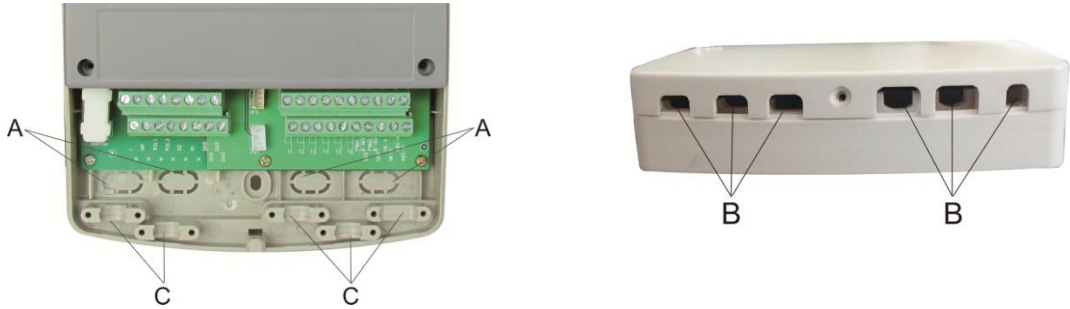

3.3 Terminal connection



Note: before opening the housing! Always disconnect the controller from power supply and obey the local electrical supply regulation.

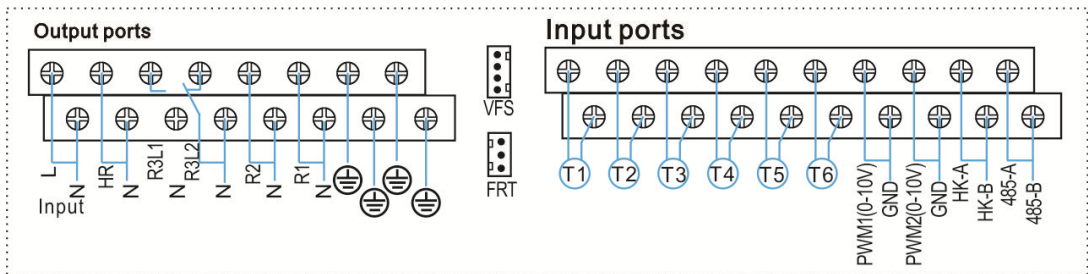

● Input ports

- T1: PT1000 temperature sensor, for measuring the temperature of collector and thermal energy calculation.
- T2 ~T6: NTC10K, B=3950 temperature sensor, for measuring temperature of tank and pipe.
- Communication port 485(selectable) : ELA485, for remote control communication (WIFI model should be purchased seperately, detailed see annexed part)
- HK-A, HK-B: Dry connection on/off signal ports, (HK and HR simultaneously open or close, for boiler heating control)
- PWM1, PWM2: Signal ports for high efficiency pump, detailed connection see below
- VFS: For Grundfos flowmeter sensor
- FRT: For rotary vane type electronic flowmeter

● **Advice regarding the installation of temperature sensors:**

- Only original factory equipped Pt1000 temperature sensors are approved for using with the controller, it is equipped with 1.5m silicon cable and suitable for all weather conditions, the cable is temperature resistant up to 280°C, connect the temperature sensors to the corresponding terminals with either polarity.
- Only original factory equipped NTC10K,B=3950 temperature sensors are approved for using with tank and pipe, it is equipped with 3m PVC cable, and the cable is temperature resistant up to 105°C, connect the temperature sensors to the corresponding terminals with either polarity.
- All sensor cables carry low voltage, and to avoid inductive effects, must not be laid close to 230 volt or 400 volt cables (minimum separation of 100mm).
- If external inductive effects are existed, e.g. from heavy current cables, overhead train cables, transformer substations, radio and television devices, amateur radio stations, microwave devices etc., then the cables to the sensors must be adequately shielded.
- Sensor cables may be extended to a maximum length of ca. 100 meter, when cable's length is up to 50m, and then 0.75mm² cable should be used. When cable's length is up to 100m, and then 1.5mm² cables should be used.

● **Output ports**

- FU1: 2A/250V fuse
- Input Ports L, N: for power connection, L: live wire, N: zero wire,  protective wire
- Output R1: Semiconductor relays (SCR), designed for pump speed control, Max. Current: 2A
- Output R2: Semiconductor relays (SCR), designed for pump speed control, Max. Current: 2A
- Output R3: Electromagnetic relays, designed for on/off control of pump or 3-ways electromagnetic valve, Max. Current: 2A
- Output HR: Electromagnetic relays, designed for on/off control of after heating/thermostat function, Max. Current: 2A

3.4 R3 ports for 3-ways valve / pump connection

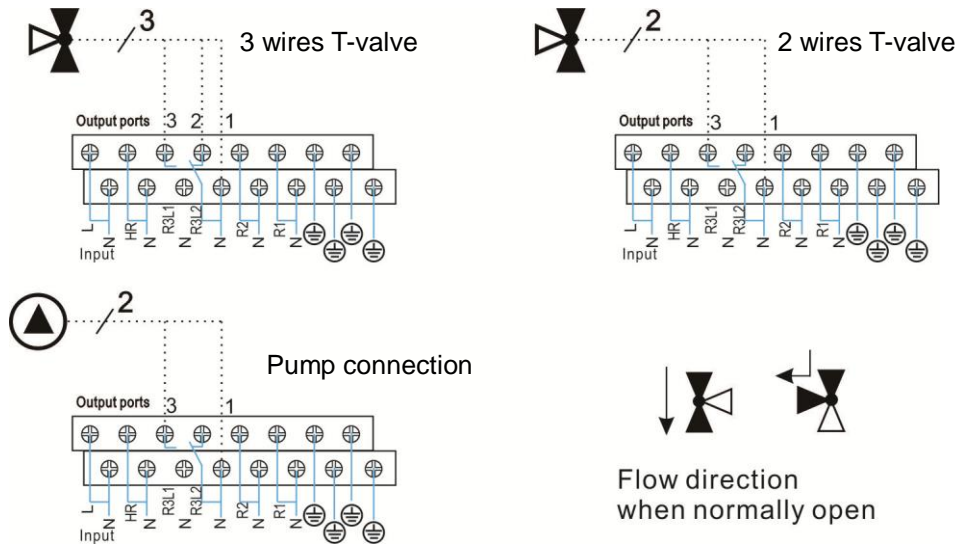

When R3 is for controlling 3 ways electromagnetic valve, (3 is normally open port, 2 is normally close port, 1 is common port)

When R3 is for controlling pump, (3 is normally open port, 1 is common port)

3.5 Connection with high efficiency pump

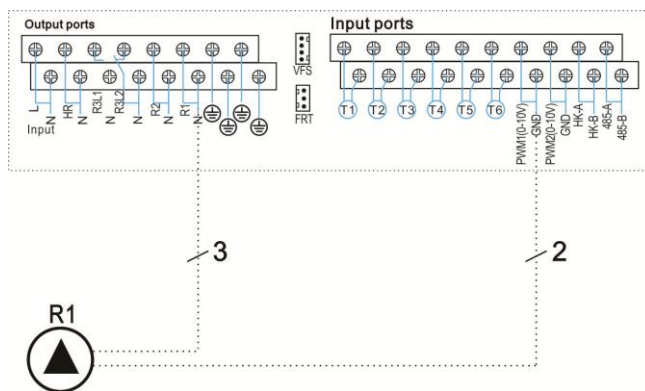

- **Connecting the signal wire from the high-efficiency pump**

Signal	Overmoulded Pin	Cable color
PWM input (from controller)	1	Grey or blue
PWM common	2	brown
PWM output (from the pump)	3	black

Signal wire 1 from the high-efficiency pump is connected to GND port of controller

Signal wire 2 from the high-efficiency pump is connected to PWM1 port of controller

Signal wire 3 from the high-efficiency pump is not connected to the controller

Some pumps connections are available as above, for example:

Wilo Yonos PARA ST15/7.0 PWM2 M

Grundfos UPM3 SOLAR 15-75 130 CZA

Note:

1. High-efficiency pump with 0-10V signal only has 2 signal wires, connected to the corresponding port GND, PWM1 of controller.
2. Blue wire not always represent for "GND" and brown wire not always represent for "PWM".
 - "PWM" from pump must be match for "PWM" from controller.
 - "GND" from pump must be match for "GND" from controller.

4. System description (Standard solar system with 1 tank, 1 collector field)

Description:

The controller calculates the temperature difference between collector sensor T1 and tank sensor T2. If the difference is larger than or identical to the adjusted switch-on temperature difference, the solar circulation pump (R1) will be switched on and the tank will be loaded until the switch-off temperature difference or the maximum tank temperature is reached.

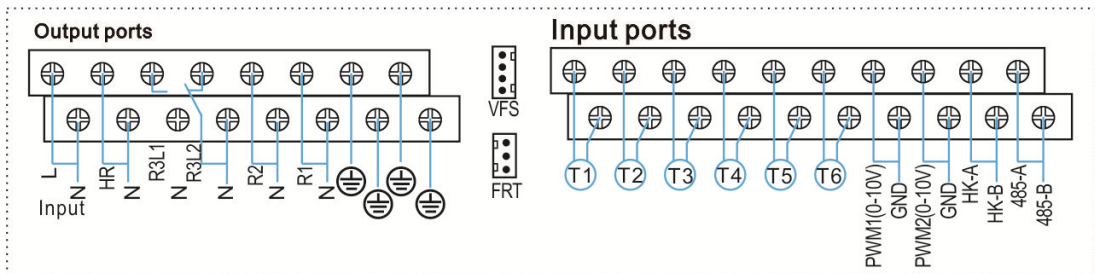
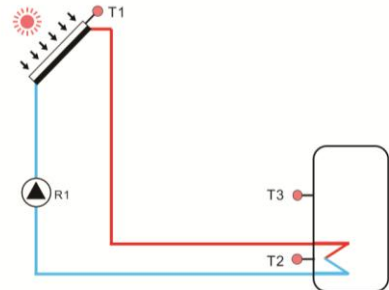

Sensor	Description	Relay	Description
T1	Temperature of collector Pt1000	R1	Solar circulation pump
T2	Temperature of tank base NTC10K	R2	Available selectable functions: 1.HEAT (Heat exchange between tanks) 2.OHDP (Thermal transfer,R2 or R3 selectable) 3.SFB (Solid fuel boiler)
T3	Temperature of tank upper (selectable) NTC10K		
T4	Selectable sensor, free, NTC10K		
T5	Selectable sensor, free NTC10K	R3	1. CIRC (DHW circulation) 2. OPAR (Parallel relay)
T6	Temperature on pipe for thermal energy measurement (selectable) NTC10K	HR	After heating/thermostat function



Note:

1. Sometime, for one selected function, it needs an extra input to connect temperature sensor or an extra output to control pump or electromagnetic valve, in the case all inputs and outputs are in using, and then this selected function will not be triggered even when you have activated it. Controller can distinguish it automatically and switch-off this function.
2. When one of these three functions (HEAT, OHDP, SFB) is activated, and then the other two will be deactivated automatically.
3. When one of these two functions (CIRC, OPAR) is activated, and then the other one will be deactivated automatically.

5. Function's parameters and options

5.1 Overview of menu structure

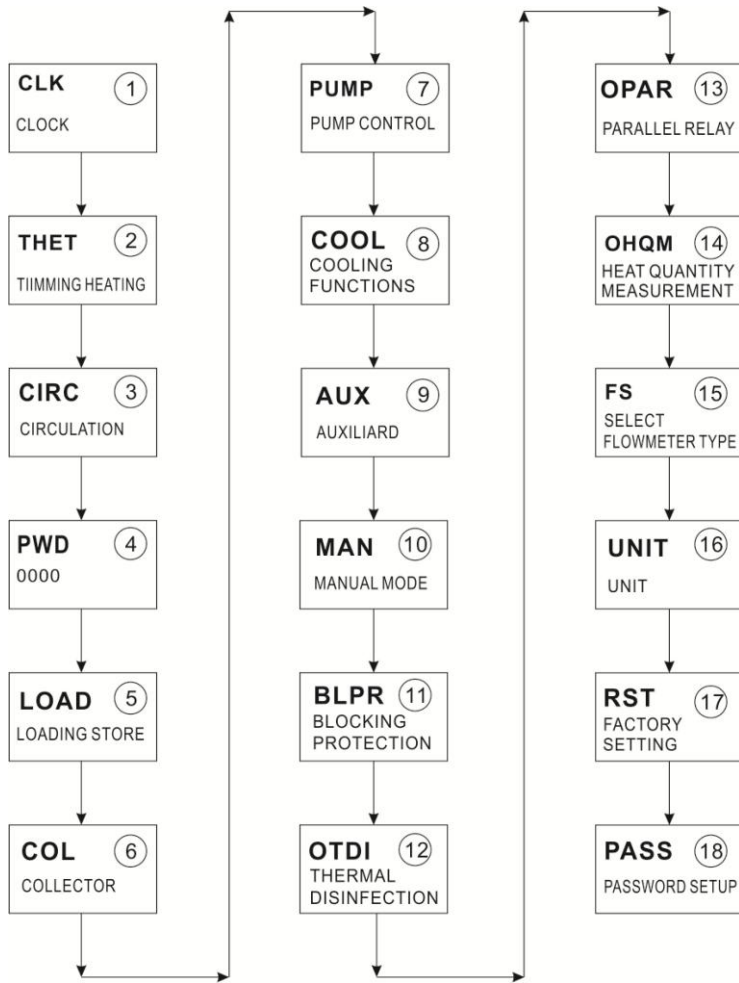

5.2 Menu operation description

- Access main menu
 - ▶ Press “SET” button to access main menu
 - ▶ Press “▲/▼” to select menu
 - ▶ Press “SET” button to enter the submenu

- Access submenu
 - ▶ After selecting main menu, then press “SET” button to access submenu
 - ▶ Press “▲/▼” button to select submenu,
 - ▶ Press “SET” button to enter the value adjust interface or selection function (select

ON/OFF)

▶ Press “▲/▼” to adjust value

▶ Press “SET” to confirm the value you set

i **Note:** Enter the menu adjustment interface, if you don't press any button in 3 minutes, screen will exit the adjustment and return to the main interface.

5.3 Value checking

At the normal operation mode, press “▲/▼” button, you can view the temperature of collector and tank, pump speed(n1%), accumulated pump running time(hR1), accumulated thermal energy(kWh or MWh), flow rate(L/M), controller running time (DAYS), software version (SW).

Under the checking status, when the digital flow meter is failed, (L/M 0.0) will display on the flow meter, it is possible to quickly set the flow meter type to a fixed flow rate (mechanical flow meter), doing follow steps:

▶ Press “▲/▼” button, select flow rate, (L/M 0.0) displays.

▶ Press “SET” button for 3 seconds, beeper sounds “du...” 3 times, and then flow rate is set to a fixed value (read from mechanical flow meter). Electronic flow meter is switched off.

i **Note:**

- Flow rate display, sterilization function, auxiliary function and parallel relays function can only be displayed only when the function is activated.
- When sterilization function is running, sterilization time can be checked, when auxiliary function is running, corresponding signal blinks on the screen
- Thermal energy is showed as kWh under kWh channel, is showed as MWh under MWh channel, total accumulation of thermal energy produced by solar system is the plus of kWh + MWh
- Enter the value check interface, if you don't press any button within 3 minutes, screen will exit the check interface and turn to main interface.

5.4 Function checking

Under standby status, press “SET” button for 3 seconds, then press “▲/▼” button to check the type of pump.

6. Functions operation and parameters setting (for user)

6.1 CLK Time setup

Menu structure

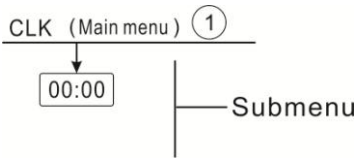

- ▶ Press “SET” button, select CLK menu
- ▶ Press “SET” button, hour “00” blinks on the display.
- ▶ Press “▲/▼” button to adjust hour
- ▶ Press “SET” button, minute time “00” blinks on the display
- ▶ Press “▲/▼” button to adjust minute
- ▶ Press “SET” or “ESC” button to save the set value



i Note: In the case power to controller is switched-off, date and time will be remembered in controller for 36 hours.

6.2 THET Timing heating

Electrical back-up heater can be installed in the solar system to ensure the tank's temperature meets the required temperature, this electrical heater can be controlled automatically by this controller, when tank temperature T3 drops below the switch-on set point of this function, electrical heater HR is triggered to heat tank up to the switch-off temperature, and then electrical heater HR stops working.

It is possible to set three time sections for activating this function,
Factory default set:

The first time section: heating starts at 00:00am, stops at 23:59am

The second time section: heating starts at 00:00, stops at 00:00

The third time section: heating starts at 00:00, stops at 00:00

And switch on temperature is set at 40°C, switch-off temperature is set at 45°C

If you want to shut off one timing heating ,then you can set the turning on time and turning off time with a same value(for example, set second start time tA2 O at 00:00 and set the stop time tA2 F at 00:00)

Every day three timing heating can be set, and the switch-on temperature adjustable range is 0°C ~ (OFF-2 °C), switch-off temperature adjustable range is (ON+2 °C) ~ 95 °C.

Wire connection to boiler on/off signal.

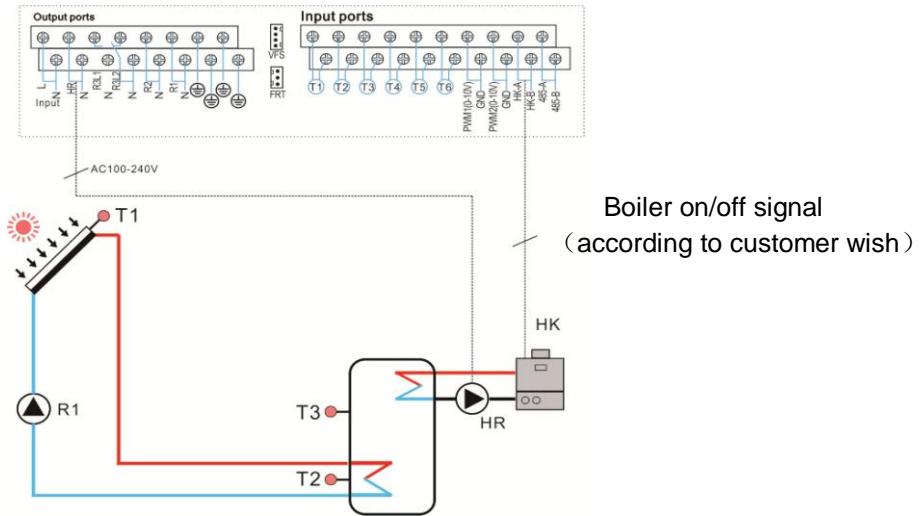

When boiler as back-up device is selected, then back-up heating (HK and HR) is controlled by tank's sensor T3 or T2 (selectable), if the T3's or T2's value is lower than the switch-on temperature of back-up heating, the output relay HK and HR is switched on, when T3 or T2 is higher than the switch-off temperature of back-up heating, the output relay HK and HR are switched-off.

i Note: If customer use electrical heater as back-up, please according to the power of electrical heater to equip corresponding safety devices like contactor and breaker with this controller, we strongly recommend equipping with SR802 device with this controller, (SR802 detailed technical data see item 10 Accessories)

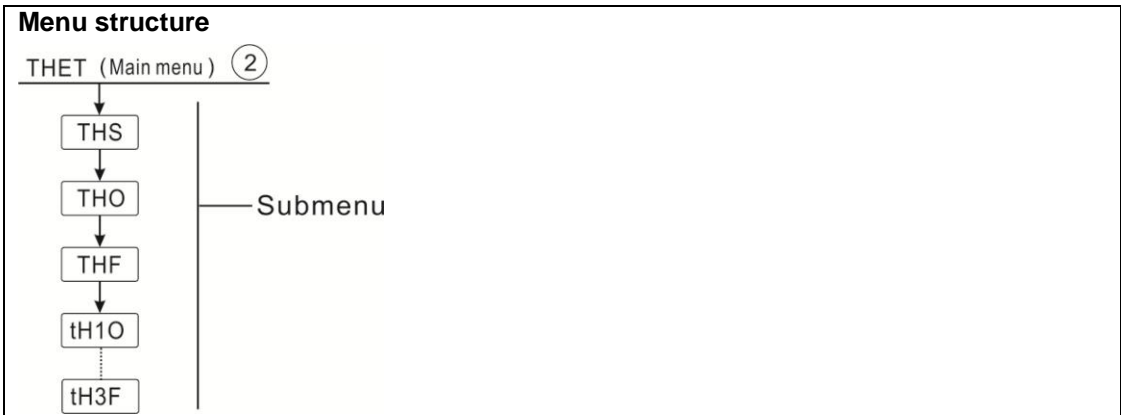

Main menu	Submenu	Factory set	Adjustable range	Step per adjust	Description
THET					Timing heating
	THS	S3	S2. S3		Select desired sensor for timing heating function (S3 for T3, S2 for T2)
	THO	40°C		0.5°C	Switch-on temperature of timing heating
	THF	45°C		0.5°C	Switch-off temperature of timing heating
	tH1O	00:00	00:00-23:59		Switch-on time of the first timing heating
	tH1F	23:59	00:00-23:59		Switch-off time of the first timing heating
	t H2O	00:00	00:00-23:59		Switch-on time of the second timing heating
	tH2F	00:00	00:00-23:59		Switch-off time of the second timing heating
	tH3O	00:00	00:00-23:59		Switch-on time of the third timing heating
	tH3F	00:00	00:00-23:59		Switch-off time of the third timing heating

Function setting:

- ▶ Press “SET” button to access main menu, and press “▲” to select THEH timing heating main menu.
- ▶ Press “SET” button to set parameter, select the reference sensor of tank, “THS S3” displays on the screen.
- ▶ Press “SET” button, “S3” blinks
- ▶ Press “▲/▼” button to select desired sensor (S3 for T3, S2 for T2)
- ▶ Press “SET” or “ESC” button to save the setting.
- ▶ Press “▲” button, “THO 40°C” displays on the screen
- ▶ Press “SET” button, “40°C” blinks
- ▶ Press “▲/▼” button to adjust the switch-on temperature.
- ▶ Press “SET” or “ESC” button to save the setting.
- ▶ Press “▲” button, “THF 45°C” displays on the screen
- ▶ Press “SET” button, temperature “45°C” blinks
- ▶ Press “▲/▼” button to adjust the switch-off temperature.
- ▶ Press “SET” or “ESC” button to save the setting.
- ▶ Press “▲” button to set the first time section, start time “tH1O 04:00” displays on the



screen



- ▶ Press “SET” button, hour time “04” blinks
- ▶ Press “▲/▼” button to adjust hour of the switch-on time
- ▶ Press “SET” button, minute time “00” blinks
- ▶ Press “▲/▼” button to adjust minute of the switch-on time
- ▶ Press “SET” or “ESC” button to save the setting.
- ▶ Press “▲” button, “tH1F 05:00” displays on the screen
- ▶ Press “SET” button, hour time “05” blinks
- ▶ Press “▲/▼” button to adjust hour of the switch-off time
- ▶ Press “SET” button, minute time “00” blinks
- ▶ Press “▲/▼” button to adjust minute of the switch-off time
- ▶ Press “SET” or “ESC” button to save the setting.
- ▶ Press “▲” button to access the window of the switch-on time of the second time section, repeat above steps to set time for the second and third time section.

When heating sign  blinks on the screen, it indicates that timing-heating function is activated.



Note:

The Sign  represents whether timing heating function is on or off.

1. Within the preset time section, heating sign  is lighted on the screen
2. Out of the preset time section, heating sign  doesn't display on the screen.

6.3 CIRC DHW circulation pump controlled by temperature or by time

Function description:

This controller provides an output for running DHW circulation pump, which can be controlled by a temperature, at this case, an extra circuit pump (connect to the output R3 option) and an extra temperature sensor installed on the hot water return pipe (connect to the input T4) should be installed in the system. When the temperature of DHW return is lower than the preset switch-on temperature, circuit pump is triggered, until temperature rises up to the switch-off temperature, pump is stopped.

2 controlling modes are designed for running DHW circulation pump.

- **Time controlled DHW pump within the preset 3 time sections (default Mode)**

Within the preset time section, when running of the DHW circulation pump R3 is controlled by time, at this case, pump is triggered by time, as default set, pump R3 runs for 3 minutes

(adjustable range 1-30 minutes) and then ceases for 15 minutes (adjustable range 0-60 minutes), same process repeated within the preset time section.

i **Note:** if the ceased time (CYCF) is set to 0 minute, it means within this time section, circuit pump keeps running without any stop.

Default time section setup:

The first time section: start at 05:00, stop at 7:00

The second time section: start at 11:00, stop at 13:00

The first time section: start at 17:00, stop at 22:00

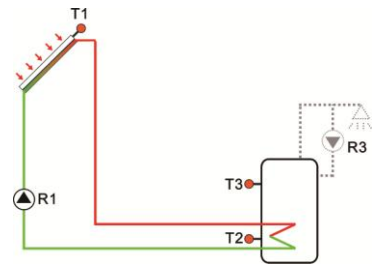

● **Temperature controlled DHW pump within the preset 3 time sections**

within the preset time section, when running of the DHW circulation pump is controlled by temperature, as default set, pump R3 is triggered when return temperature T4 is below 40°C, and it is stopped when T4 rises up to 45°C,

There is a precondition for triggering the DHW circuit pump (set in submenu STAT):

START ON: tank's temperature sensor (T3 as priority

selection) is 2°C higher than the preset switch-off temperature, and then DHW circuit pump can be triggered.

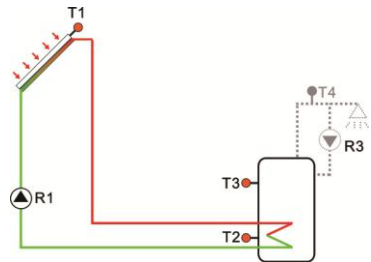

i **Note:** two Modes can't play at the same time, when time controlled Mode is selected, then temperature controlled Mode can't be activated.

Default time section setup:

The first time section: start at 05:00, stop at 7:00

The second time section: start at 11:00, stop at 13:00

The first time section: start at 17:00, stop at 22:00

If it is needed to close one time section, just set the start time and stop time at a same value (e.g. 10:00 starts, 10:00 stops)

i **Note:**

1. Only one controlling Mode can be selected, either time control Mode or temperature control Mode.
2. If sensor T4 should be installed, in order to avoid measuring error, please ensure to install the sensor at 1.5m far to tank.

3. Both control Modes and temperature control mode, the parameter set steps are same.

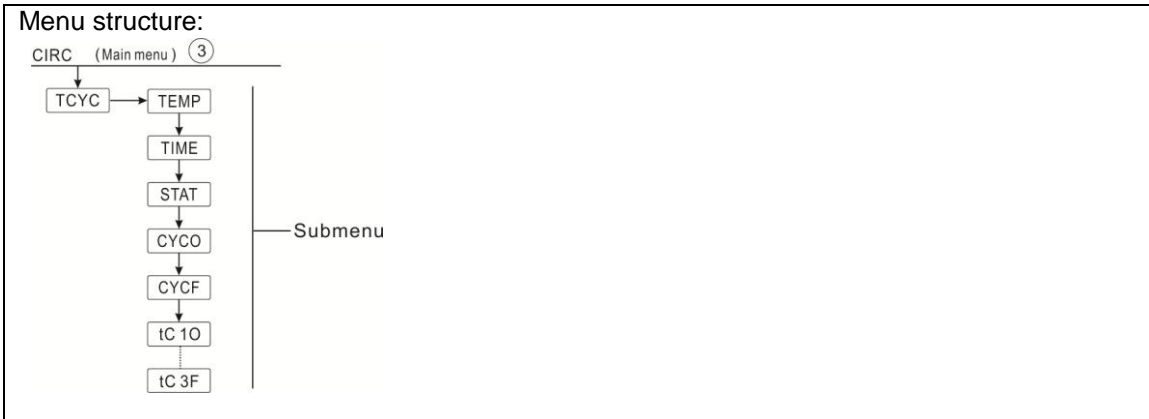

Main menu	Submenu 1	Submenu 2	Factory set	Adjustable range	Step per adjust	Description
CIRC						DHW circuit function
	TCYC		OFF	ON/OFF		Activate / deactivate the DHW circuit function
		TEMP	OFF			Temperature control DHW pump
		TIME	ON			Time control DHW pump
		STAT	ON	ON/OFF		Tank temperature (T3 or T2) 2°C higher than the preset switch-off DHW circuit temperature.
		CYCO	40 °C /3min	5-53 °C /1-30min	0.5 °C /1min	Switch-on temperature or running time
		CYCF	45 °C /15min	7-55 °C /0-60min	0.5 °C /1min	Switch-off temperature or stop time
		tC10	05:00	00:00-23:59		Switch-on time and temperature for the first time section
		tC1F	07:00	00:00-23:59		Switch-off time and temperature for the first time section
		tC2O	11:00	00:00-23:59		Switch-on time and temperature for the second time section

		t C2F	13:00	00:00-23:5 9		Switch-off time and temperature for the second time section
		t C3O	17:00	00:00-23:5 9		Switch-on time and temperature for the third time section
		t C3F	22:00	00:00-23:5 9		Switch-off time and temperature for the third time section

Function setup: (take temperature controlled DHW as example)

- ▶ Select main menu CIRC DHW circuit function
- ▶ Press “SET” button, “TCYC” displays on the screen.
- ▶ Press “SET” again, “TCYC OFF” displays on the screen
- ▶ Press “SET”, “OFF” blinks
- ▶ Press “▲/▼” button to activate this function
- ▶ Press “SET” or “ESC” button to save the setting

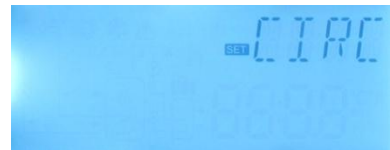

- ▶ Press “▲” button, “TEMP OFF” displays on the screen (temperature control Mode)
- ▶ Press “SET”, “OFF” blinks
- ▶ Press “▲/▼” button to activate this function
- ▶ Press “SET” or “ESC” button to save the setting.

- ▶ Press “▲” button, “TIME ON” displays on the screen (time control Mode, default as on)
- ▶ Press “SET”, “ON” blinks
- ▶ Press “▲/▼” button to deactivate this function
- ▶ Press “SET” or “ESC” button to save the setting.

- ▶ Press “▲” button, “STAT ON” displays on the screen (Switch-on condition under temperature control Mode, under time control Mode, no this function)
- ▶ Press “SET”, “ON” blinks (default as open)
- ▶ Press “▲/▼” button to deactivate this function
- ▶ Press “SET” or “ESC” button to save the setting.

- ▶ Press “▲” button, “CYCO 40°C” displays on the screen, set the switch-on temperature of

DHW circuit (if select time control Mode, then “ CYCO 03Min” displays, here take temperature mode as example)

▶ Press “SET”, “40°C” blinks

▶ Press “▲/▼” button to adjust the switch-on temperature (adjustable range 0°C ~ (OFF-2°C))

▶ Press “SET” or “ESC” button to save the setting.

▶ Press “▲” button, “CYCF 45°C” displays on the screen, set the switch-off temperature of DHW circuit

▶ Press “SET”, “45°C” blinks

▶ Press “▲/▼” button to adjust the switch-off temperature (adjustable range ON+2°C ~ 55°C)

▶ Press “SET” or “ESC” button to save the setting.

▶ Press “▲” to access 3 time sections setting, “tC1O 05:00” displays on the screen, set the start time of the first time section.

▶ Press “SET”, time hour “05” blinks,

▶ Press “▲/▼” to adjust hour of the circuit start time.

▶ Press “SET”, time minute “00” blinks,

▶ Press “▲/▼” to adjust minute of the circuit start time.

▶ Press “SET” or “ESC” button to save the setting.

▶ Press “▲” to access the stop time of the first time section, “tC1F 07:00” displays on the screen,

▶ Press “SET”, time hour “07” blinks,

▶ Press “▲/▼” to adjust hour of the circuit stop time.

▶ Press “SET”, time minute “00” blinks,

▶ Press “▲/▼” to adjust minute of the circuit stop time.

▶ Press “SET” or “ESC” button to save the setting.

▶ Press “▲” to access the start time of the second time section, repeat above step to set start and stop time for second and third time section.

If you want to close the DHW circuit within one time section, and then just set its start time and close time with a same value, for example, at the second time section, start time is set at 10:00, but close time is also set at 10:00.

7. Function operation and parameter setup (engineer)

7.1 PWD Password

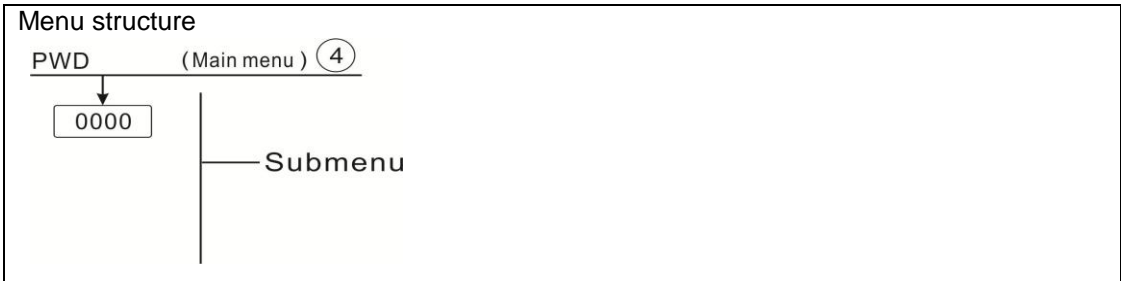

Access main menu, select “PWD 0000” to enter password

- ▶ Press “SET” button, the left digital blinks, enter password, factory set is “0000”
- ▶ Press “▲/▼”, to enter the first digital
- ▶ Press “SET”, the second digital blinks
- ▶ Press “▲/▼” to enter the second digital
- ▶ Press “SET”, the third digital blinks
- ▶ Press “▲/▼” to enter the third digital
- ▶ Press “SET”, the fourth digital blinks
- ▶ Press “▲/▼” to enter the fourth digital
- ▶ Press “SET”, to access main menu



Through password set to limit the user to change some parameters, 4 digitals needed.

Default is 0000

If no password is set, then just press “SET” five times to access main menu directly

7.2 LOAD tank heating

Function description:

- ΔT control logic

The controller works as a standard temperature differential controller. If the temperature reaches or exceeds the switch-on temperature difference (DTO), the pump R1 switches on. When the temperature difference reaches or falls below the adjusted switch-off temperature difference (DTF), the respective relay of R1 switches off.

i **Note:** The switch-on temperature difference must be 0.5 K higher than the switch-off temperature difference. The set temperature difference must be at least 0.5 K higher than the switch-on temperature difference.

● **Speed control**

If the temperature reaches or exceeds the switch-on temperature difference, the pump switches on at 100% speed for 10s. Then, the speed is reduced to the minimum pump speed value.

If the temperature difference reaches the preset temperature difference, the pump speed increases by one step (10%). The response of the controller can be adapted via the parameter RIS. If the difference increases by the adjustable rise value RIS, the pump speed increases by 10% until the maximum pump speed of 100% is reached. If the temperature difference decreases by the adjustable rise value (RIS), pump speed will be decreased by one step 10% accordingly.

i **Note:** To enable speed control function, the corresponding pump type has to be set to (MIN, MAX) and relay control has to be set to (PULS, PSOL, PHEA or 0-10 V) (under adjustment menu PUMP).

● **SMX Maximum tank temperature protection set**

If the tank temperature reaches the adjusted maximum temperature, the tank will no longer be loaded in order to avoid damage caused by overheating. If the maximum tank temperature is exceeded, sign  is displayed on the screen.

The sensor for tank maximum limitation (SMAX) can be selected. The maximum limitation always refers to the sensor selected (T2 or T3). The switch-on hysteresis (HYST) is selectable(Default is 2°C), for example, when tank maximum temperature is set to 70°C, then at 68 °C, Maximum tank temperature protection function is deactivated automatically.

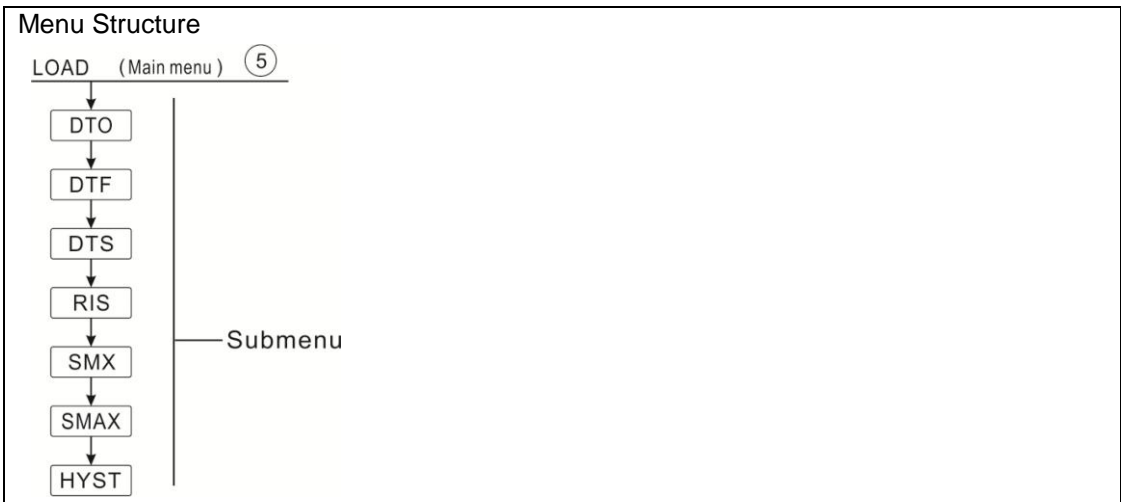

Main menu	Submenu	Factory set	Adjustable range	Step per adjust	Description
LOAD					Tank heating
	DTO	6K	1-50K	0.5K	Switch-on temperature difference of tank heating
	DTF	4K	0.5-49.5K	0.5K	Switch-off temperature difference of tank heating
	DTS	10K	1.5-50K	0.5K	Temperature difference of pump speed control
	RIS	2K	1-20K	1K	Rise range of pump speed control
	SMX	70℃	4-95℃	1℃	Maximum temperature of tank
	SMAX	S3	S2. S3		Sensor for Maximum temperature of tank (S3 for T3, S2 for T2)
	HYST	2K	0.1-10K	0.1K	Hysteresis of maximum temperature of tank

Setup the functions

- ▶ Select “LOAD” main menu
- ▶ Press “SET”, “DTO 6K” displays on the screen
- ▶ Press “SET”, “6K” blinks
- ▶ Press “▲/▼”, to adjust the switch-on temperature of the solar circuit pump.
- ▶ Press “SET” or “ESC” to save the setting
- ▶ Press “▲”, “DTF 4K” displays on the screen
- ▶ Press “SET”, “4K” blinks
- ▶ Press “▲/▼”, to adjust the switch-off temperature of solar circuit pump
- ▶ Press “SET” or “ESC” to save the setting
- ▶ Press “▲”, “DTS 10K” displays on the screen
- ▶ Press “SET”, “10K” blinks
- ▶ Press “▲/▼”, to adjust the standard temperature difference of solar circuit pump
- ▶ Press “SET” or “ESC” to save the setting
- ▶ Press “▲”, “RIS 2K” displays on the screen
- ▶ Press “SET”, “2K” blinks
- ▶ Press “▲/▼”, to adjust the rise range of pump speed control





- ▶ Press “SET” or “ESC” to save the setting
- ▶ Press “▲”, “SMX 70°C” displays on the screen
- ▶ Press “SET”, “70°C” blinks
- ▶ Press “▲/▼”, to adjust the maximum temperature of tank
- ▶ Press “SET” or “ESC” to save the setting
- ▶ Press “▲”, “SMAX S3” displays on the screen
- ▶ Press “SET”, “S3” blinks
- ▶ Press “▲/▼”, select the sensor for maximum temperature of tank (S3 for T3, S2 for T2)
- ▶ Press “SET” or “ESC” to save the setting
- ▶ Press “▲”, “HYST 2K” displays on the screen
- ▶ Press “SET”, “2K” blinks
- ▶ Press “▲/▼”, to adjust the hysteresis of tank maximum temperature
- ▶ Press “SET” or “ESC” to save the setting

7.3 COL Collector function

Function description

- **OCEM Collector emergency shutdown**

When the collector temperature exceeds the adjusted collector emergency temperature, Then solar pump (R1) switches off in order to protect the system components against overheating (collector emergency shutdown). If the maximum collector temperature (OCEM) is exceeded, sign   is displayed.

 **Warning!** Risk of injury! Risk of system damage by pressure surge! If water is used as the heat transfer fluid in pressurized systems, water will boil at 100 °C. Then do not set the collector limit temperature higher than 95 °C.

- **OCCO Collector cooling**

The collector cooling function keeps the collector temperature rising within the operating range by heating the tank. If the tank temperature reaches 95°C the function will be switched off for safety reasons.

When the tank temperature exceeds the adjusted maximum temperature of tank, then solar system is switched off. If the collector temperature rises up to its adjusted maximum collector temperature, the solar pump is switched on again until the collector temperature falls below the maximum collector temperature. The tank temperature may then exceed its maximum

temperature, but only up to 95°C (emergency shutdown of the tank), and sign  blinks on the screen, system stops.

If the collector cooling is active,  blinks on the screen.

This function is only available when the system cooling function (OSYC) and the heat transfer function (OHDP) are not activated.

- **OCMI Collector minimum temperature**

The minimum collector temperature is the lowest temperature for running the solar system, only when collector temperature is higher than this temperature, solar pump (R1) just can be switched-on, if the collector temperature falls below the adjusted minimum temperature, and the function will be activated, sign  blinks on the screen slowly.

- **OCFR Collector antifreeze function**

Collector antifreeze function activates the loading circuit between the collector and the tank when the collector temperature falls below the adjusted temperature **CFRO**. This will protect the fluid against freezing or coagulating. If collector temperature exceeds the switch-off temperature of collector antifreeze function CFRF, the solar pump will be switched off again.

If collector antifreeze function is activated, sign  blinks on the screen slowly.



Note: Since this function uses the limited heat which is saved in the tank, so the antifreeze function should be used in regions where ambient temperatures is around the freezing point only for a few days.

- **OTCO Tube collector function**

This function is used for improving the switch-on behavior in systems with non-ideal sensor positions (e. g. with some tube collectors).

This function operates within an adjusted time section. It activates the collector circuit pump R1 for an adjustable runtime between adjustable pauses in order to compensate for the delayed temperature measurement.

If the runtime is set to more than 10s, the pump will run at 100% for the first 10s of the runtime. For the remaining runtime, the pump will run at the adjusted minimum speed.

If the collector sensor is defective or the collector is blocked, this function will be switched off.

Menu structure

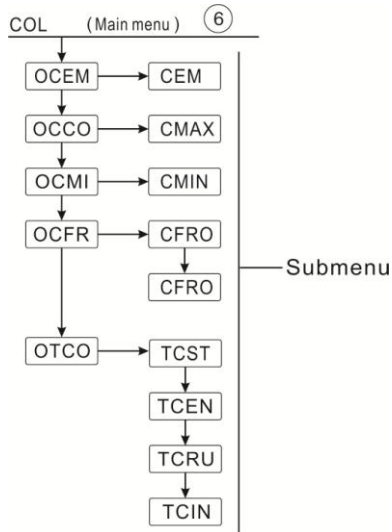

Main menu	Submenu 1	Submenu 2	Factory set	Adjustable range	Step per adjust	Description
COL						Collector function
	OCEM		ON			Collector emergency shutdown function on/ff
		CEM	130℃	80-200℃	1℃	Temperature of collector emergency shutdown(hysteresis 10K)
	OCCO		OFF			Collector cooling function on/off
		CMAX	110℃	70-160℃	1℃	Temperature of collector cooling (hysteresis 5K)
	OCMI		OFF			Collector minimum temperature function on/off
		CMIN	10℃	10-90℃	1℃	Temperature of collector minimum function
	OCFR		OFF			Anti-freeze function on/off
		CFRO	4℃	-40-8℃	0.5℃	Switch-on temperature of anti-freeze function

		CFRF	5°C	-39-9°C	0.5°C	Switch-off temperature of anti-freeze function
	OTCO					Tube collector function
		TCST	07:00	00:00-23:00	1min	Start time of tube collector function
		TCEN	19:00	00:00-23:00	1min	Stop time of tube collector function
		TCRU	30s	30-300s	1s	Pump runtime during tube collector function
		TCIN	30min	5-60min	1min	Pump stop time during tube collector function

Function setting:

OCEM (Collector emergency shutdown function) setup

- ▶ Select “COL” function menu
- ▶ Press “SET”, “OCEM” displays on the screen
- ▶ Press “SET” again, “OCEM ON” displays on the screen
- ▶ Press “SET”, “ON” blinks on the screen



(If it is necessary to shut down this function, press “▲/▼” to deactivate it)

- ▶ Press “SET” or “ESC” to save the setting
- ▶ Press “▲”, “OCEM 130°C” displays on the screen
- ▶ Press “SET”, “130°C” blinks on the screen
- ▶ Press “▲/▼”, to activate or deactivate the collector emergency function
- ▶ Press “SET” or “ESC” to save the setting
- ▶ Press “ESC” to return to the previous menu

OCCO (Collector cooling function) setup

- ▶ Press “▲”, “OCCO” displays on the screen
- ▶ Press “SET”, “OCEM OFF” displays on the screen
- ▶ Press “SET”, “OFF” blinks on the screen
- ▶ Press “▲/▼”, to activated this function, “OCEM ON” displays on the screen
- ▶ Press “▲”, “CMAX 110°C” displays on the screen
- ▶ Press “▲/▼”, to adjust the switch-on temperature of collector cooling function
- ▶ Press “SET” or “ESC” to save the setting

- ▶ Press “ESC” to return to previous menu

OCMI (Collector minimum temperature) setup

- ▶ Press “▲”, “OCMI” displays on the screen
- ▶ Press “SET”, “OCMI OFF” displays on the screen
- ▶ Press “SET”, “OFF” blinks on the screen
- ▶ Press “▲/▼”, to activate this function, “OCMI ON” displays on the screen
- ▶ Press “▲”, “OCMI 10°C” displays on the screen
- ▶ Press “▲/▼”, to adjust the minimum temperature of collector
- ▶ Press “SET” or “ESC” to save the setting
- ▶ Press “ESC” to return to previous menu

OCFR (Antifreeze function) setup

- ▶ Press “▲”, “OCFR” displays on the screen
- ▶ Press “SET”, “OCFR OFF” displays on the screen
- ▶ Press “SET”, “OFF” blinks on the screen
- ▶ Press “▲/▼”, to activate this function, “OCFR ON” displays on the screen
- ▶ Press “▲”, “CFRO 4°C” displays on the screen
- ▶ Press “SET”, “4°C” blinks on the screen
- ▶ Press “▲/▼”, to adjust the switch-on temperature of antifreeze function
- ▶ Press “SET” or “ESC” to save the setting
- ▶ Press “▲”, “CFRF 5°C” displays on the screen
- ▶ Press “SET”, “5°C” blinks on the screen
- ▶ Press “▲/▼”, to adjust the switch-off temperature of antifreeze function
- ▶ Press “SET” or “ESC” to save the setting
- ▶ Press “ESC” to return to the previous menu

OTCO (Tube collector function) setup

- ▶ Press “▲”, “OTCO” displays on the screen
- ▶ Press “SET”, “OTCO OFF” displays on the screen
- ▶ Press “SET”, “OFF” blinks on the screen
- ▶ Press “▲/▼”, to activated this function, “OTCO ON” displays on the screen
- ▶ Press “▲”, “TCST 07:00” displays on the screen
- ▶ Press “SET”, “07” blinks
- ▶ Press “▲/▼”, to adjust hour

- ▶ Press “SET”, “00” blinks on the screen
- ▶ Press “▲/▼”, to adjust minute
- ▶ Press “SET” or “ESC” to save the setting
- ▶ Press “▲”, “TCEN 19:00” displays on the screen
- ▶ Press “SET”, “19” blinks
- ▶ Press “▲/▼” to adjust hour
- ▶ Press “SET”, “00” blinks
- ▶ Press “▲/▼”, to adjust minute
- ▶ Press “SET” or “ESC” to save the setting
- ▶ Press “▲”, “TCRU 30” displays on the screen
- ▶ Press “SET”, “30” blinks
- ▶ Press “▲/▼”, to adjust runtime
- ▶ Press “SET” or “ESC” to save the setting
- ▶ Press “▲”, “TCIN 30Min” displays on the screen
- ▶ Press “SET”, “30” blinks
- ▶ Press “▲/▼”, to adjust stop time
- ▶ Press “SET” or “ESC” to save the setting
- ▶ Press “ESC” to return to the previous menu

7.4 PUMP Pump control mode

Function description:

With this parameter, the relay control mode can be adjusted. The following modes can be selected:

- Adjustment for standard pump without speed control:
ONOF: Pump on / pump off
- Adjustment for standard pump with speed control:
PULS: Burst control via semiconductor relay
- Adjustment for high-efficiency pump (HE pump)

- PSOL: PWM profile solar pump

PWM signal logic (solar):

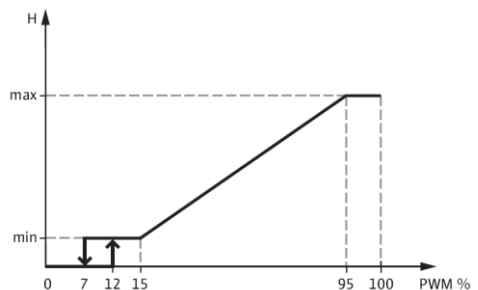

- PHEA: PWM profile heating pump

PWM signal logic (heating):

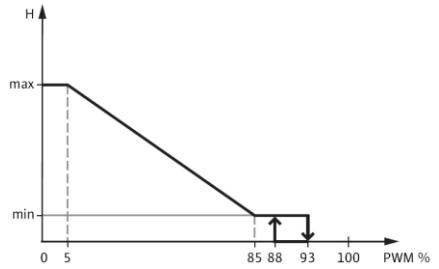

- 0-10: Speed control via 0 - 10 V signal

PWM(0-10V) signal logic

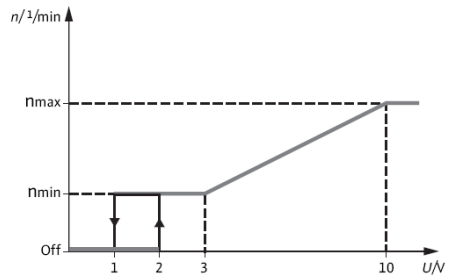

i Note:

1. More information about connection of high efficiency pump see the paragraph (3.5 Connection with high efficiency pump)
2. Minimum pump speed: Under the adjustment menu MIN1 (2), a relative minimum speed for connected pumps can be allocated to the outputs R1, R2.
3. Maximum pump speed: Under the adjustment menu MAX1 (2), a relative maximum speed for connected pumps can be allocated to the outputs R1, R2.
4. When the devices which are not speed-controlled are used (e. g. motored valves), the pump speed value of the corresponding relay must be set to 100 % or the control Mode must be set to ONOF in order to deactivate pump speed control.

i Note: PWM Relay allocation: PWM1 for R1, PWM2 for R2

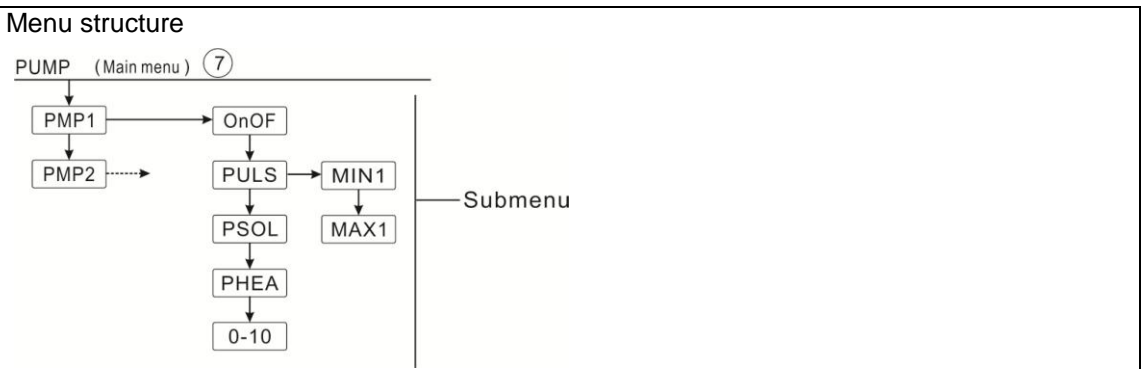

Main menu	Submenu 1	Submenu 2	Submenu 3	Factory set	Adjustable range	Step per adjust	Description
PUMP							Pump control mode
	PMP1(2.)						Selection pump R1 (R2.)
		ONOF		ON	ON/OFF		Pump on/off (for pump without speed adjustment function)
		PULS		OFF	ON/OFF		Pulse control (Burst control via semiconductor relay)
			MIN1	30%	20-95%	5%	
			MAX1	100%	25-100%	5%	
		PSOL		OFF	ON/OFF		PWM profile solar pump
			MIN1	30%	20-95%	5%	
			MAX1	100%	25-100%	5%	
		PHEA		OFF	ON/OFF		PWM profile heating pump
			MIN1	30%	20-95%	5%	
			MAX1	100%	25-100%	5%	
		0-10		OFF	ON/OFF		0-10V signal control pump speed
			MIN1	30%	20-95%	5%	
			MAX1	100%	25-100%	5%	

Function setup

- ▶ Select "PUMP" menu
- ▶ Press "SET", "PMP1" displays on the screen
- ▶ Press "SET", "ONOF ON" displays on the screen
- ▶ Press "▲/▼", to select pump type "PLUS、PSOL、PHEA、0-10V"
- ▶ After select pump type, press "SET" to access the pump type.
- ▶ Press "SET", "OFF" blinks on the screen
- ▶ Press "▲/▼" to open
- ▶ Press "SET" or "ESC" to save the setting
- ▶ Press "ESC" to return to previous menu





Note:

1. PMP2 setting process is same like PMP1
2. Only 1 type can be selected from 5 types ONOF、 PLUS、 PSOL、 PHEA、 0-10V

Example: when “PLUS ON” open option is selected, then other four types are closed automatically.

7.5 COOL Cooling function

Function description:

There are 3 cooling functions can be activated for 3 different devices: system cooling, tank cooling, heat transferring by external radiator.

● OSYC System cooling

The system cooling function aims to keep the lifetime of a solar system for a longer time. The function overrides the maximum tank temperature limitation to provide thermal relief of the collector field and the heat transfer fluid on hot days. If the tank temperature is higher than the adjusted maximum tank temperature and the switch-on temperature difference **DTCO** is reached, the solar pump remains running or will be switched on. Solar loading is continued until either the temperature difference falls below the adjusted switch-off value **DTCF** or the collector emergency shutdown temperature **OCEM** is reached.



Note: This function will only be available when the collector cooling function, external radiator heat transfer functions are not activated.

● OSTC Tank cooling

When the tank cooling function is activated, the controller aims to cool down the tank during the night in order to prepare it for solar loading on the following day. If the tank temperature exceeds the adjusted maximum tank temperature **SMAX**, the collector temperature falls below the tank temperature and down to the switch-on temperature difference **DTCO** of this cooling function, then system will be activated in order to cool down the tank by releasing the energy through the collector.

If tank cooling function is activated, sign  blinks on the screen



Note: if tank temperature reaches to 95 °C, all cooling functions will be locked.

Hysteresis switch on temperature difference is 5K.

● **OHDP Heat transferring by external radiator**

Heat transferring by external radiator function is designed to transfer the excess heat which is generated under the strong solar irradiation through an external heat exchanger (e. g. fan coil); the purpose is to keep the collector's or tank's temperature within the operating range. For this function, an extra output should be added (R2 or R3 as option)

Heat transferring by external radiator function can control either an additional pump or a valve (**OTPM ON** = pump logic, **OTPM OFF** = valve logic)

Heat transferring by external pump:

If the collector temperature reaches the adjusted switch-on temperature, the allocated relay for pump is energized with 100 %; if the collector temperature falls by 5 K below the adjusted collector overheat-temperature, the relay will be switched off. When heat transferring is achieved by pump, then the heat transferring function will be independent from solar loading. Below is the example of this application for reference.

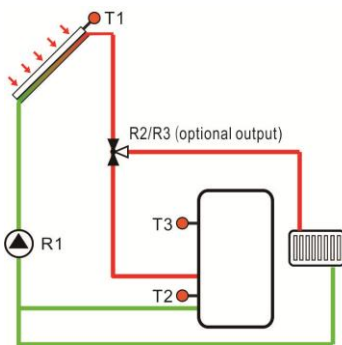

Collector heat transferring valve logic

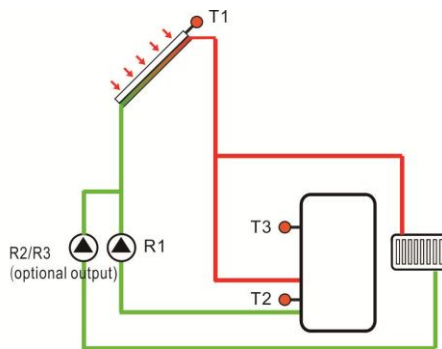

Collector heat transferring pump logic

Sign  displays on the screen, it indicates that valve logic heat transferring is running.

Sign  displays on the screen, it indicates that pump logic heat transferring is running.

i Note:

1. When collector overheat temperature OTST is 10K below the CEM temperature of collector emergency shutdown, then collector overheat temperature OTST is locked
2. Heat transferring function is only available when collector cooling function (OCCO) and system cooling function (OSYC) are deactivated.

Menu structure						
<pre> graph TD COOL[COOL (Main menu) 8] --> OSYC[OSYC] OSYC --> OSTC[OSTC] OSTC --> DTCO[DTCO] OSTC --> OHDP[OHDP] OHDP --> OTST[OTST] OTST --> OTPM[OTPM] OTPM --> REL[REL] DTCO --> DTCF[DTCF] subgraph Submenu DTCO DTCF OTST OTPM end </pre>						
Main menu	Submenu 1	Submenu 2	Factory set	Adjustable range	Step per adjust	Description
COOL						Cooling function
	OSYC		OFF	ON/OFF		System cooling function
	OSTC		OFF	ON/OFF		Tank cooling function
		DTCO	20K	1-30K	0.5K	Switch-on temperature difference of cooling function
		DTCF	15K	0.5-29.5K	0.5K	Switch-off temperature difference of cooling function
	OHDP		OFF	ON/OFF		Heat transferring by external radiator (only in case there is available output)
		OTST	80°C	20-160°C	1°C	Temperature set point for heat transferring (hysteresis 5°C)
		OTPM	ON	OTPM ON=pump logic OTPM OFF=valve logic		Pump control logic and valve control logic
		REL	R3	R3,R2		Output ports

Function setting:

OSYC (system cooling function) setting

- ▶ Select “COOL” menu
- ▶ Press “SET”, “OSYC OFF” displays on the screen
- ▶ Press “SET”, “OFF” blinks on the screen
- ▶ Press “▲/▼”, to activate this function
- ▶ Press “SET” or “ESC” to save the setting



OSTC (Tank cooling function) setting

- ▶ Press “▲” button, “OSTC” displays on the screen
- ▶ Press “SET”, “OSTC OFF” displays on the screen
- ▶ Press “SET” button, “OFF” blinks
- ▶ Press “▲/▼” to activate this function
- ▶ Press “▲”, “DTCO 20K” displays on the screen
- ▶ Press “SET”, “20K” blinks
- ▶ Press “▲/▼”, to adjust the switch on temperature difference
- ▶ Press “SET” or “ESC” to save the setting
- ▶ Press “▲”, “DTCF 15K” displays on the screen
- ▶ Press “▲/▼”, to adjust the switch-off temperature difference
- ▶ Press “SET” or “ESC” to save the setting
- ▶ Press “ESC” to return to previous menu

OHDP (Heat transferring) setting

- ▶ Press “▲”, “OHDP” displays on the screen
- ▶ Press “SET”, “OHDP OFF” displays
- ▶ Press “SET”, “OFF” blinks
- ▶ Press “▲/▼”, to activate this function, “OHDP ON” displays
- ▶ Press “▲”, “OTST 80°C” displays
- ▶ Press “SET”, “80°C” blinks
- ▶ Press “▲/▼”, to adjust the temperature of heat transferring
- ▶ Press “SET” or “ESC” to save the setting
- ▶ Press “▲” button, “OTPM ON” displays
- ▶ Press “SET”, “ON” blinks
- ▶ Press “▲/▼”, to select the control logic pump or valve
- ▶ Press “SET” or “ESC” to save the setting
- ▶ Press “▲”, “REL 3” displays
- ▶ Press “SET”, “3” blinks

- ▶ Press “▲/▼”, to select the output port for heat transferring
- ▶ Press “SET” or “ESC” to save the setting
- ▶ Press “ESC” to return to previous menu

7.6 AUX Auxiliary function

Function description:

Auxiliary functions can be set under “AUX” menu; controller can activate several auxiliary functions simultaneously.

i **Note:** Functions SFB and HEAT use the same output port R2, though only one of the functions of SFB, and HEAT can be activated, one is activated, and the other one will be automatically ceased.

● SFB solid fuel boiler function

The solid fuel boiler function is designed for transferring heat from a solid fuel boiler to a tank.

For this purpose, sensor T5 and relay output R2 are needed, and this relay is energized when below all switch-on conditions are fulfilled:

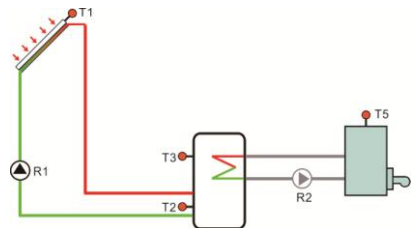

1. The temperature difference between the sensors of heat source T5 and heat sink (T3 as priority selection) has exceeded the switch-on temperature difference.
2. The temperature at the solid fuel boiler sensor T5 has exceeded its minimum temperature (MNSO)
3. The temperature at the tank sensor T3 has fallen below its maximum temperature MXSS

When the preset switch-on temperature difference is exceeded, pump speed control starts. For every increase or decrease by the rise value (RIS), the pump speed will be adjusted by 10 %.

The switch-on hysteresis is -5 K.

● HEAT Heat transferring between tanks

Heat transferring between tanks is designed to transfer thermal energy from heat source tank to the object tank. The output relay R2 is energized when below all switch-on conditions are fulfilled:

1. Temperature difference between the heat source tank ((T3 as priority selection) and object tank T4 reaches to the switch-on temperature difference.
2. Temperature of heat source tank is higher than its preset minimum temperature

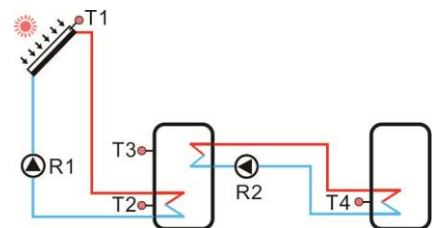

3. Temperature of object tank is lower than its preset maximum temperature.

When the preset temperature difference is exceeded, pump speed control starts. For every increase or decrease by the rise value, the pump speed will be adjusted by 10 %.

● **BEEP Beeper fault warning**

When system has fault (temperature sensor fault, no flow), beeper sends out warning.

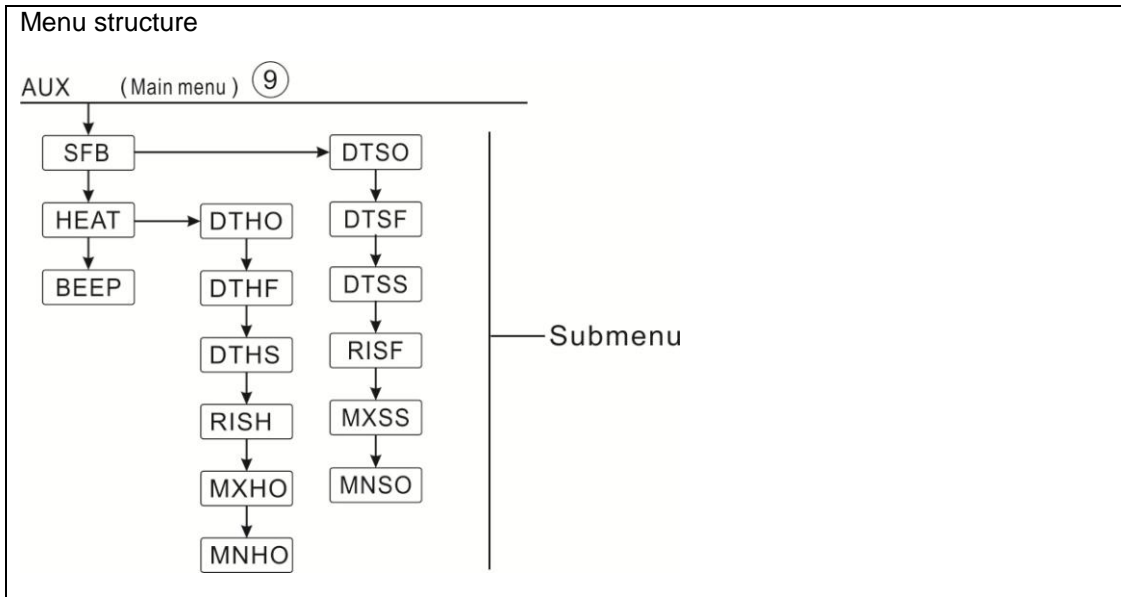

Main menu	Submenu 1	Submenu 2	Factory set	Adjustable range	Step per adjust	Description
AUX						Auxiliary functions
	SFB		OFF	ON/OFF		Solid fuel boiler function
		DTSS	6K	1-50K	0.5K	Switch-on temperature difference of SFB
		DTSF	4K	0.5-49.5K	0.5K	Switch-off temperature difference of SFB
		DTSS	10K	1.5-50K	0.5K	Pump speed control-temperature difference
		RISF	2K	1-20K	1K	Pump speed control- rise range
		MXSS	60℃	0.5-95℃	0.5℃	Maximum switch-off temperature of tank heating
		MNSO	60℃	0.5-89.5℃	0.5℃	Minimum switch-on temperature of solid fuel boiler
	HEAT		OFF	ON/OFF		Heat transferring between tanks

		DTHO	6K	1-50K	0.5K	Switch-on temperature difference of heat transferring between tank
		DTHF	4K	0.5-49.5K	0.5K	Switch-off temperature difference of heat transferring between tank
		DTSS	10K	1.5-50K	0.5K	Pump speed control-temperature difference between tanks
		RISH	2K	1-20K	1K	Pump speed control- rise range between tanks
		MXHO	70℃	0.5-95℃	0.5℃	Maximum temperature of object tank
		MNHO	60℃	0.5-89.5℃	0.5℃	Minimum temperature of heat source tank
	BEEP		OFF	ON/OFF		Beeper warning function (sensor fault, no flow)

Function setup

SFB (Solid fuel boiler) setting

- ▶ Select AUX main menu, access “SFB” setting window
- ▶ Press “SET”, “SFB” displays on the screen
- ▶ Press “SET”, “SFB OFF” displays
- ▶ Press “SET”, “OFF” blinks
- ▶ Press “▲/▼”, to activate this function, “SFB ON” displays
- ▶ Press “SET” or “ESC” to save the setting
- ▶ Press “▲”, “DTSO 6K” displays on the screen
- ▶ Press “SET”, “6K” blinks
- ▶ Press “▲/▼”, to adjust the switch-on temperature difference
- ▶ Press “SET” or “ESC” to save the setting
- ▶ Press “▲”, “DTSF 4K” displays on the screen
- ▶ Press “SET”, “4K” blinks
- ▶ Press “▲/▼”, to adjust the switch-off temperature difference
- ▶ Press “SET” or “ESC” to save the setting
- ▶ Press “▲”, “DTSS 10K” displays on the screen
- ▶ Press “SET”, “10K” blinks
- ▶ Press “▲/▼”, to adjust the standard temperature difference of pump
- ▶ Press “SET” or “ESC” to save the setting



- ▶ Press “▲”, “RISF 2K” displays on the screen
- ▶ Press “SET”, “2K” blinks
- ▶ Press “▲/▼”, to adjust the rise range
- ▶ Press “SET” or “ESC” to save the setting
- ▶ Press “▲”, “MXSS 60°C” displays on the screen
- ▶ Press “SET”, “60°C” blinks
- ▶ Press “▲/▼”, to adjust the maximum shutdown temperature of tank
- ▶ Press “SET” or “ESC” to save the setting
- ▶ Press “▲”, “MNSO 60°C” displays on the screen
- ▶ Press “▲/▼”, to adjust the lowest switch-on temperature of solid fuel boiler
- ▶ Press “SET” or “ESC” to save the setting
- ▶ Press “ESC” to return to previous menu

HEAT (Heat transferring between tanks) setting

- ▶ Press “▲”, “HEAT” displays
- ▶ Press “SET”, “HEAT OFF” displays
- ▶ Press “SET”, “OFF” blinks
- ▶ Press “▲/▼”, to activate this function, “HEAT ON” displays on the screen
- ▶ Press “SET” or “ESC” to save the setting
- ▶ Press “▲”, “DTHO 6K” displays
- ▶ Press “SET”, “6K” blinks
- ▶ Press “▲/▼”, to adjust the switch-on temperature difference of 2 tanks
- ▶ Press “SET” or “ESC” to save the setting
- ▶ Press “▲”, “DTHF 4K” displays on the screen
- ▶ Press “SET”, “4K” blinks
- ▶ Press “▲/▼”, to adjust the switch-off temperature difference of 2 tanks
- ▶ Press “SET” or “ESC” to save the setting
- ▶ Press “▲”, “DTHS 10K” displays on the screen
- ▶ Press “SET”, “10K” blinks
- ▶ Press “▲/▼”, to adjust the standard temperature difference of pump
- ▶ Press “SET” or “ESC” to save the setting
- ▶ Press “▲”, “RISH 2K” displays on the screen
- ▶ Press “SET”, “2K” blinks
- ▶ Press “▲/▼”, to adjust rise range
- ▶ Press “SET” or “ESC” to save the setting

- ▶ Press “▲”, “MXHO 70°C” displays on the screen
- ▶ Press “SET”, “70°C” blinks
- ▶ Press “▲/▼”, to adjust the maximum temperature of heated tank
- ▶ Press “SET” or “ESC” to save the setting
- ▶ Press “▲”, “MNHO 60°C” displays on the screen
- ▶ Press “▲/▼”, to adjust the lowest temperature of heat source tank
- ▶ Press “SET” or “ESC” to save the setting
- ▶ Press “ESC” to return to previous menu

BEEP (Beeper warning function) setting

- ▶ Press “▲”, “BEEP” displays on the screen
- ▶ Press “SET”, “BEEP OFF” displays on the screen
- ▶ Press “SET”, “OFF” blinks
- ▶ Press “▲/▼”, to activate this function, “BEEP ON” displays on the screen
- ▶ Press “SET” or “ESC” to save the setting

7.7 MAN Manual operation

For control and service work, the operating mode of the relays can be manually adjusted. For this purpose, select the adjustment menu MAN (for R1, R2, R3, HR) to set output “On/OFF” Manually.

i **Note:** When manual mode is activated, sign  blinks on the screen, controller runs for 15 minutes and then switch-off all output, control exits manual mode automatically.

Main Menu	Submenu	Factory set	Adjustable range	Description
MAN				Manual mode
	R1	OFF	ON/OFF	R1 on and off
	R2	OFF	ON/OFF	R2 on and off

	R3	OFF	ON/OFF	R3 on and off
	HR	OFF	ON/OFF	HR on and off

Function setup

- ▶ Press “▲”, “R1” displays on the screen
- ▶ Press “SET”, “R1 OFF” displays
- ▶ Press “SET”, “OFF” blinks
- ▶ Press “▲/▼”, to activate this function, “R1 ON” displays
- ▶ Press “SET” or “ESC” to save the setting
- ▶ Press “▲”, “R2” displays, repeat above steps to set the manual output of R2, R3, HR.



7.8 BLPR Blocking protection

Function description:

In order to protect the pumps against blocking after standstill, the controller is equipped with a blocking protection function. This function switches on the relays one after another every day at 12:00 a.m and pump runs for 10s at 100 % speed.

Menu structure

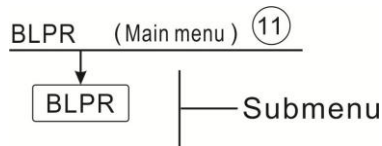

Function setting

- ▶ Press “▲”, “BLPR” displays on the screen
- ▶ Press “SET”, “BLPR OFF” displays
- ▶ Press “SET”, “OFF” blinks
- ▶ Press “▲/▼”, to activate this function, “BLPR ON” displays on the screen
- ▶ Press “SET” or “ESC” to save the setting



7.9 OTDI Thermal Disinfection function

Function description:

This function helps to prevent the spread of Legionella in DHW tanks by systematically activating the after-heating.

For thermal disinfection, the temperature at the allocated sensor has to be monitored. During the monitoring period PDIS, this protection ensures the disinfection temperature is

continuously exceeded the disinfection temperature TDIS for the entire disinfection period DDIS. Thermal disinfection can only be completed when the disinfection temperature is exceeded for the duration of the disinfection period without any interruption.

The monitoring period PDIS starts as soon as the temperature at the allocated sensor falls below the disinfection temperature TDIS, once the monitoring period PDIS ends, disinfection period SDIS starts, and the allocated reference relay activates the after-heating, when tank temperature exceeds the disinfection temperature, disinfection phase DDIS starts and disinfection heating time countdowns, countdown finishes, disinfection heating finishes.

Menu structure					
Menu	Submenu	Factory set	Adjustable range	Step per adjust	Description
OTDI		OFF	ON/OFF		Disinfection function
	PDIS	7d	0-30d	1d	Time section of disinfection monitoring
	DDIS	10min	1-180	1min	Heating time of disinfection
	TDIS	70°C	0-90°C	1°C	Temperature of disinfection
	SDIS	18:00	00:00-21:00	1:00	Start time of disinfection

Function setting

- ▶ Press “▲”, “OTDI” displays on the screen
- ▶ Press “SET”, “OTDI OFF” display
- ▶ Press “SET”, “OFF” blinks
- ▶ Press “▲/▼”, to activate this function, “OTDI ON” displays
- ▶ Press “SET” or “ESC” to save the setting
- ▶ Press “▲”, “PDIS 7” displays
- ▶ Press “SET”, “7” blinks
- ▶ Press “▲/▼”, to adjust the days for disinfection monitoring,



- ▶ Press “SET” or “ESC” to save the setting
- ▶ Press “▲”, “DDIS 10Min” displays on the screen
- ▶ Press “SET”, “10” blinks
- ▶ Press “▲/▼”, to adjust the heating time of disinfection
- ▶ Press “SET” or “ESC” to save the setting
- ▶ Press “▲”, “TDIS 70°C” displays on the screen
- ▶ Press “SET”, “70°C” blinks
- ▶ Press “▲/▼”, to adjust the temperature of disinfection
- ▶ Press “SET” or “ESC” to save the setting
- ▶ Press “▲”, “SDIS 18:00” displays on the screen
- ▶ Press “SET”, “18” blinks
- ▶ Press “▲/▼”, to adjust the start time of the disinfection
- ▶ Press “SET” or “ESC” to save the setting

7.10 OPAR Parallel relay

Function description:

With this function, e. g. a valve can be controlled in parallel to the pump via a separate relay. If solar loading starts to run (R1) or if a solar function is active, the selected parallel relay (R3) will be energized at the same time. The parallel relay can also be de-energized inversely. INVE OFF means R1 triggered, parallel reply R3 also triggered. INVE ON, means R1 closed, but parallel reply R3 is triggered



Function setting

- ▶ Select OPAR menu
- ▶ Press “SET”, “OPAR OFF” displays on the screen
- ▶ Press “SET”, “OFF” blinks
- ▶ Press “▲/▼”, to activate this function, “OPAR ON” displays ▶ Press “SET” or “ESC” to save the setting
- ▶ Press “▲”, “INVE OFF” displays
- ▶ Press “SET”, “OFF” blinks



- ▶ Press “▲/▼” to activate this function, “INVE ON” displays
- ▶ Press “SET” or “ESC” to save the setting

7.11 OHQM Thermal quantity measurement

The thermal quantity measurement can be carried out in 3 different ways:

- Fixed flow rate (use flow meter with glass window)
- With Granados flow rotor VFS
- With rotary vane flow mater FRT

● Thermal quantity measurement with fixed flow rate value

The thermal quantity measurement calculation (estimation) uses the temperature difference between the flow sensor T6 and return sensor T5 and the entered flow rate (at 100 % pump speed).

i **Note:** sensor of flow and return pipe for thermal quantity measurement is default set in solar system, it can not be reset.

● Under menu FTYP to set the flow rate type to 1

Read the flow rate (l/min) and enter it in the **FMAX** menu

Under menu **MEDT** and **MED%** to set the antifreeze medium type and concentration of the heat transfer fluid

Antifreeze type:

- 0: Water
- 1: Propylene glycol
- 2: Ethylene glycol
- 3: Tyfocol LS / G-LS

● Thermal quantity measurement with Grundfos Direct Sensor VFS

The thermal quantity measurement uses the temperature difference between flow sensor T6 and return sensor TVFS and the flow rate transmitted by the VFS sensor.

TVFS: Temperature of Grundfos Direct sensor VFS

i **Note:**

1. Sensor of flow and return pipe for thermal quantity measurement is default set in the solar system, it can not be reset.
2. Flow checking function is only available when a VFS type Grundfos Direct Sensor is connected to the

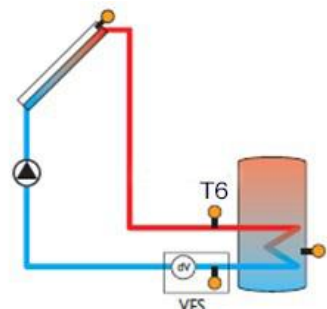

controller.

3. If select Grundfos sensor VFS to calculate heat quantity, firstly you should activate VFS function under menu FS/GFDS (VFS ON), and select measurement range, default value is 1-12L/min.
4. Under FTYP menu to set the flow rate type to 2 (VFS)

Under menu **MEDT** and **MED%** to set the antifreeze type and concentration of the heat transfer fluid

T6: temperature sensor on the flow pipe

TVFS: temperature sensor on the return pipe

If VFS is not connected correctly, sign   blinks on the sensor

● **Thermal quantity measurement with rotary vane flow meter(FRT)**

Under menu FTYP, set the flow type to 3(FRT)

The thermal quantity measurement uses the temperature difference between flow sensor T6 and return sensor T5 and the flow rate transmitted by the FRT flow meter.

Under menu **MEDT** and **MED%** to set the antifreeze medium type and concentration of the heat transfer fluid

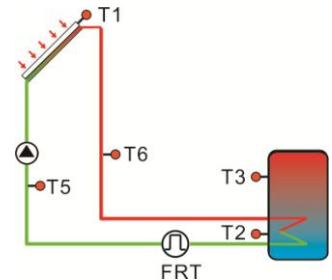

i **Note:** when rotary vane flow meter (FRT) is selected for thermal quantity calculation, then it needs to activate FRT (FRT ON) under menu FS/FRT.

Menu structure

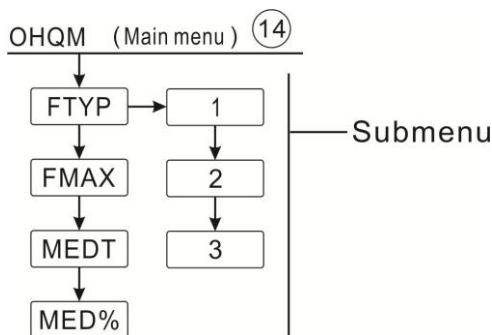

Menu	Submenu 1	Submenu 2	Factory set	Adjustable range	Step per adjust	Description
OHQM			OFF	ON/OFF		Thermal quantity measurement

	FTYP					Flow meter selection
		1	1			Flow meter with fixed flow value
		2				Grundfos flow meter (VFS)
		3				Rotary vane flow meter (FRT)
	FMAX		6L/min	0.5-100L/min	0.1	Flow rate enter
	MEDT		3	0-3		Medium type 0: water 1: Propylene glycol 2: Ethylene glycol 3: Tyfocol LS/G-LS;
	MED%		45%	20-70%	1%	Concentration of medium

Function setting

- ▶ Select OHQM menu
- ▶ Press “SET”, “OHQM OFF” displays on the screen
- ▶ Press “SET”, “OFF” blinks
- ▶ Press “▲/▼”, to activate this function, “OHQM ON” displays on the screen
- ▶ Press “SET” or “ESC” to save the setting
- ▶ Press “▲”, “FTYP 1” displays
- ▶ Press “SET”, “1” blinks
- ▶ Press “▲/▼”, select type of the flow meter (1, 2, and 3)
- ▶ Press “SET” or “ESC” to save the setting
- ▶ Press “▲”, “FMAX 6” displays on the screen
- ▶ Press “SET”, “6” blinks
- ▶ Press “▲/▼”, to adjust flow rate
- ▶ Press “SET” or “ESC” to save the setting
- ▶ Press “▲”, “MEDT 3” displays on the screen
- ▶ Press “SET”, “3” blinks
- ▶ Press “▲/▼”, to select medium type
- ▶ Press “SET” or “ESC” to save the setting
- ▶ Press “▲”, “MED% 45” displays on the screen
- ▶ Press “SET”, “45” blinks
- ▶ Press “▲/▼”, to adjust the concentration of medium



► Press “SET” or “ESC” to save the setting



7.12 FS Flow meter selection and flow rate monitoring

Under this menu, it is possible to set the flow meter (VFS, FRT) on or off and set its measuring range.



FLOW (flow monitoring)

Function description

Flow monitoring function is designed to detect whether flow exists in the solar system and therefore to switch-off the corresponding pump in case of no flow, it can avoid damaging of the solar system, for example, avoiding pump dry running

If relay R1 is powered, flow rate of flow sensor will be monitored. After a delay detection time (DELA), if no flow rate is detected, error message will appear, and sign   will blinks on the screen.

If “OFF” option of the flow monitoring function is activated, and then the loaded tank is stopped to be heated until error message is removed, then monitoring function is activated again.

 **Note:** if the selected flow meter is not connected to the controller, sign  will blinks on the screen.

Menu structure							
<div style="display: flex; align-items: center;"> <div style="margin-right: 20px;"> <p>FS (Main menu) 15</p> <p>↓</p> <div style="border: 1px solid black; padding: 2px; width: 40px; text-align: center;">VFS</div> <p>↓</p> <div style="border: 1px solid black; padding: 2px; width: 40px; text-align: center;">FRT</div> <p>↓</p> <div style="border: 1px solid black; padding: 2px; width: 40px; text-align: center;">FLOW</div> <p>↓</p> <div style="border: 1px solid black; padding: 2px; width: 40px; text-align: center;">DELY</div> </div> <div style="border-left: 1px solid black; padding-left: 10px;"> <p>Submenu</p> </div> </div>							
Main menu	Submenu 1	Submenu 2	Submenu 3	Factory set	Adjustable range	Step per adjust	Description
FS							Register flow meter sensor
	GFDS						
		VFS	OFF	OFF	OFF / ON		Groundfos flow meter sensor

			1-12				Measuring range of Groudfos flow meter(1-12 L/min)
			2-40				Measuring range of Groudfos flow meter (2-40 L/min)
	FRT		OFF	OFF	OFF / ON		Rotary vane flow meter
			FLOW	OFF	ON/OFF		Non flow warning
			DELY	30s	1-600s	1s	Checking time of non flow warning

Function setting

- ▶ Select FS menu
- ▶ Press “SET”, “GFDS” displays on the screen
- ▶ Press “SET”, “VFS OFF” displays
- ▶ Press “▲/▼”, to activate this function, “VFS 1-12V” displays on the screen
- ▶ Press “▲/▼”, select the range of Groudfos flow meter
- ▶ Press “SET” or “ESC” to save the setting
- ▶ Press “▲”, “FLOW OFF” displays on the screen
- ▶ Press “SET”, “OFF” blinks
- ▶ Press “▲/▼”, to activate this function, “FLOW ON” displays
- ▶ Press “SET” or “ESC” to save the setting
- ▶ Press “▲”, “DELY 30” displays on the screen
- ▶ Press “SET”, “30” blinks
- ▶ Press “▲/▼”, to adjust the checking time of non-flow warning
- ▶ Press “SET” or “ESC” to save the setting
- ▶ Press “ESC” to return to previous menu
- ▶ Press “▲”, “FRT” displays on the screen
- ▶ Press “SET”, “FRT OFF” displays
- ▶ Press “SET”, “OFF” blinks

- ▶ Press “▲/▼”, to activate this function, “FRT ON” displays
- ▶ Press “SET” or “ESC” to save the setting
- ▶ Press “▲”, “FLOW OFF” displays, repeat above steps.

7.13 UNIT C-F Switch

Under this menu, below unit can be set:

TEMP: temperature

ENEG: thermal quantity, 1 is for KWH, 2 is for BTU

The units can be switched during operation.

Menu structure				
UNIT (Main menu) ⑰				
<pre> graph TD UNIT[UNIT (Main menu) ⑰] --> TEMP[TEMP] TEMP --> ENEG[ENEG] </pre>				
Submenu				
Main Menu	Submenu	Factory set	Adjustable range	Description
UNIT				Unit switch menu
	TEMP	°C	°C / °F	°C – °F switch
	ENEG	1(Wh)	1(Wh) /2(BTU)	Thermal energy unit switch

Function setting

- ▶ Select UNIT menu
- ▶ Press “SET”, “TEMP °C” displays on the screen
- ▶ Press “SET”, “°C” blinks
- ▶ Press “▲/▼”, to select temperature unit
- ▶ Press “SET” or “ESC” to save the setting
- ▶ Press “▲”, “ENEG 1” displays on the screen
- ▶ Press “SET”, “1” blinks
- ▶ Press “▲/▼”, to select thermal energy unit
- ▶ Press “SET” or “ESC” to save the setting



7.14 RET Reset

By means of the reset function, all adjustments can be reset to the factory settings.

RSTP (Menu parameters): through reset function, all parameters can be reset to factory

setting

CHQM (accumulated thermal quantity): accumulated thermal quantity can be reset to 0

CPT (accumulated running time of pump): accumulated solar pump running time (R1 time/R2 time) can be reset to 0.



Function setting

▶ Select RST menu

▶ Press “SET”, “RSTP” displays on the screen

▶ Press “SET”, “YES” blinks

▶ Press “SET” for 3 seconds, beeper sounds “di” 3 times, “YES” lighting, and it indicates system is recovered to factory set.

▶ Press “ESC” return to the submenu

▶ Press “▲”, “CHQM” displays, repeat above steps to reset the CHQM, CPT parameters.

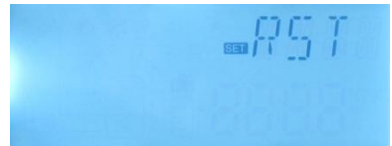

7.15 PASS Password setup

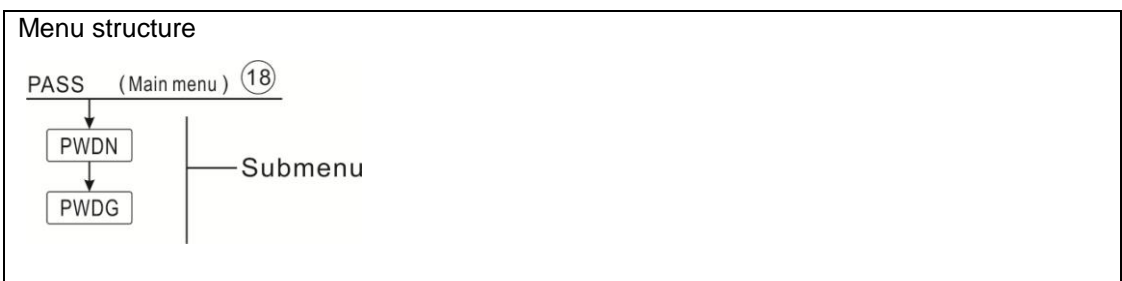

Function Setting

Select the password setting, “PASS” menu

▶ Press “SET” button, “PWDN 0000” displays on the screen, to enter the new password

▶ Press “SET” button again, the first digital blinks



▶ Press “▲/▼”, to enter the correct digital, repeats same process to enter the second, the third and the fourth digital.

▶ Press “SET” button, “PWDG 0000” displays on the screen, to enter the new password again, after confirm the new password, “OK” displays on the screen, it indicates the new password setting successfully.



Note: If the password is forgot, it is impossible to recover, but you can recover the password to the factory set, then you can reedit a password like above described steps, doing like following to recover to factory set.

▶ Switch-off the power to controller

▶ Hold down “ESC” button

▶ Reconnect the power supply, when beeper sounds 3 di....., and then release “ESC” button, Controller recovers to the factory set password (factory set password is 0000),

7.16 M.H Manual heating



Function Description:

It is possible to trigger back-up heating manually with this controller to heat tank. When tank temperature is lower than the set point of the switch-on temperature, manual heating function is in standby, when you press the manual heating button, heating will start, and it works until tank temperature reaches to the set point.

Activate/deactivate this function:

▶ Press “M.H” button for 3 seconds, temperature “60°C” blinks on the screen

▶ Press “▲/▼”, to adjust the desired temperature, adjustable range 10°C~80°C, factory set is 60°C

▶ Press “M.H” or “ESC” or waiting for 20 seconds to trigger the manual heating, then manual sign  lighted on the screen, and the heating sign  blinks the screen

▶ Press “M.H” again, switch-off manual heating.



Note: 1. Manual heating is not a continuous heating process, it is triggered manually, and when the temperature reaches to the set point, the heating process is stopped. And manual heating function is stopped automatically.

7.17 Holiday function



The holiday function is used for operating the system when no water consumption is expected, e. g. during a holiday absence. This function cools down the system in order to

reduce the thermal load.

2 cooling functions are available: tank cooling (OSTC) and tank heat transfer (OHDP).

 **Note:** Controller is designed to run tank heat transfer (OHDP) function priority, when tank heat transfer (OHDP) function is deactivated, then tank cooling function (OHTC) runs automatically in turn.

Activate/deactivate this function:

- ▶ Press “  ” button for 3 seconds, “HDAY 05” displays on the screen
- ▶ Press “ ▲/▼ ”, to adjust holiday’s days, adjustable range 0-99 days
- ▶ Press “  ” again, holiday function is closed

 **Note:** When you return from holiday, please deactivate this function in time.

8. Protection function

8.1 Memory function during power failure

When power of controller is failed, and when power is switched-on again, controller will keep the parameters which set before power failure.

8.2 Screen protection

When no any press on button for 5 minutes, screen protection is activated automatically, and then LED background lamp is switched-off. Through press any button to light LED lamp again.

8.3 Trouble checking

The built-in controller is a qualified product, which is conceived for years of continuous trouble-free operation. If a problem occurs, the most of causes is from the peripheral components but no relation with controller itself. The following description of some well-known problems should help the installer and operator to isolate the problem, so that the system can be put into operation as quickly as possible and to avoid unnecessary cost. Of course, not all possible problems can be listed here. However, most of the normal problems encountered with the controller can be found in the list below, only return the controller to seller when you are absolutely sure that none of the problems listed below is responsible for the fault.

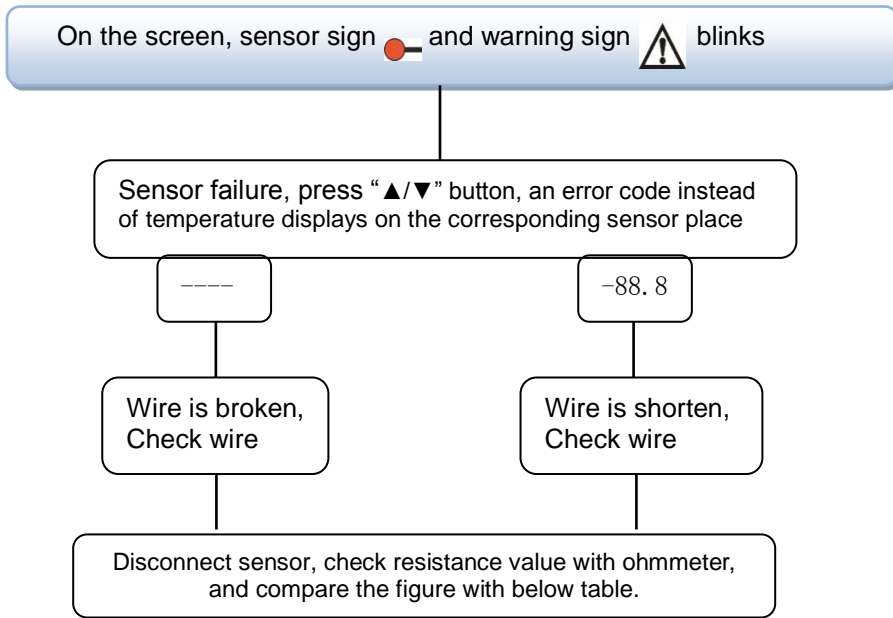

PT1000 resistance value

℃	0	10	20	30	40	50	60	70	80	90	100	110	120
Ω	1000	1039	1077	1116	1155	1194	1232	1270	1309	1347	1385	1422	1460

NTC 10K B=3950 resistance value



℃	0	10	20	30	40	50	60	70	80	90	100	110	120
Ω	33620	20174	12535	8037	5301	3588	2486	1759	1270	933	697	529	407

9. Quality Guarantee

Manufacturer provides following quality responsibilities to end-users: within the period of quality responsibilities, manufacturer will exclude the failure caused by production and material selection. A correct installation will not lead to failure. When a user takes incorrect handling way, incorrect installation, improper or crude handling, and wrong connection of Warm water outflow upwards?

The quality warranty expires within 18 months after the date of purchasing the controller.

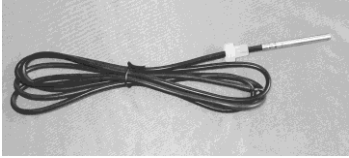
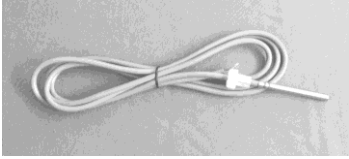
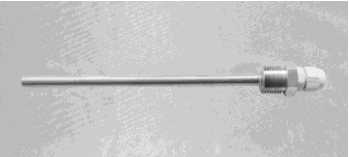
10. Accessories

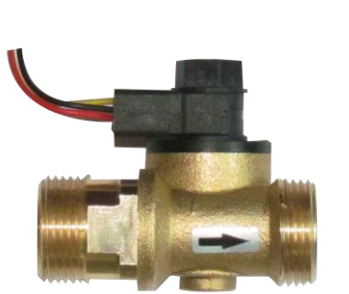
Products name	Specification	Products picture
A01: High accurate Pt1000 sensor for collector	PT1000, $\Phi 6 \times 50\text{mm}$	
A02: High accurate sensor for tank and pipe	NTC10K, B=3950, $\Phi 6 \times 50\text{mm}$	
A05: 304 stainless steel thermo well	304 stainless steel with thread 1/2' OT, Size: $\Phi 8 \times 200$	
WIFI To 485 Mode	Input: AC100-240V Output: DC5V/1A Current: 50mA Baud rate: 9600bit/s	
A13: Grundfos Direct Sensor VFS	1-12l/min; 2-40l/min	
A17:FRT digital flow meter	Parameter: male thread 3/4 Power: 5-24V/DC	

<p>SR802 Unit for high power electrical heater</p>	<p>Dimension:100mm*100mm*65mm Power supply: AC180V ~ 264V, 50/60Hz Suitable power: ≤ 4000W Available ambient temperature: -10 ~ 50°C Waterproof grade: IP43</p>	
--	---	--

● SR802 connection diagram

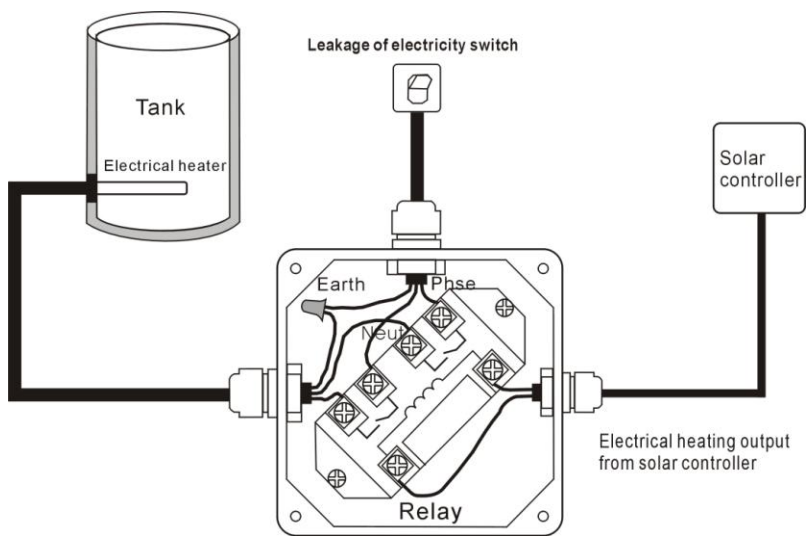

Note: Switch-off power, and perform by profession installer.